

**SAVE THESE INSTRUCTIONS**

DEALER/INSTALLER: GIVE TO HOMEOWNER

**OCEAN BLUE**

**“GRAND ENTRANCE” POOL STEPS**

ASSEMBLY AND INSTALLATION MANUAL

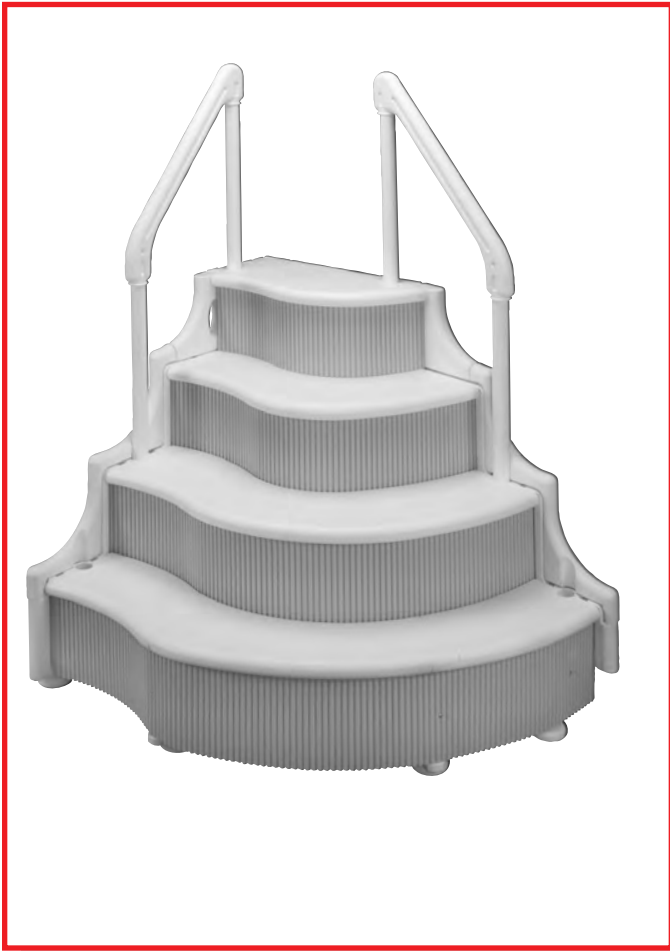

ABOVE GROUND FOUR TREAD MODEL  
Part No. 400700

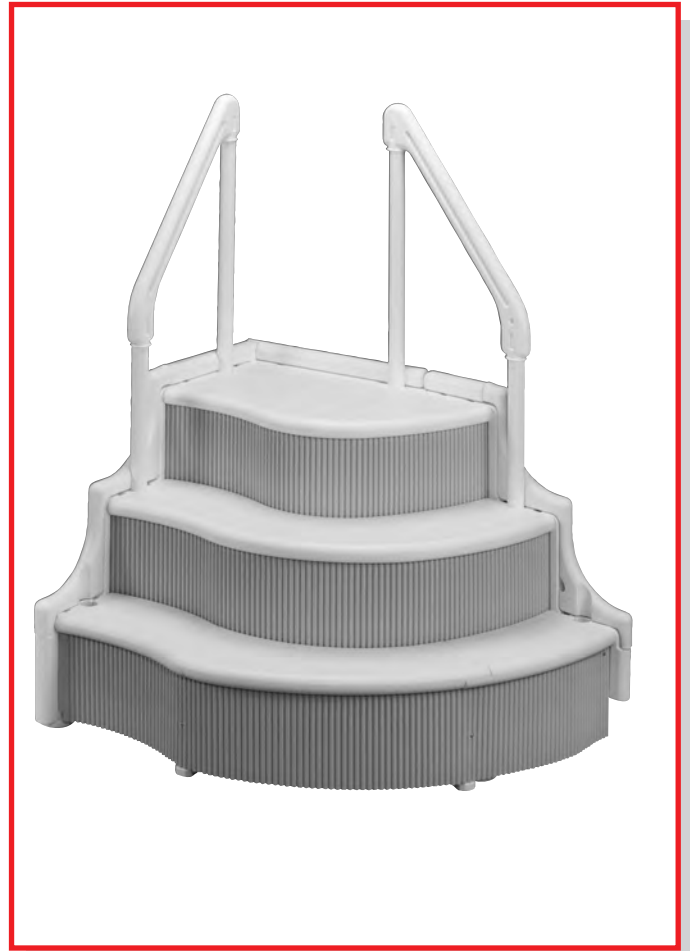

IN GROUND THREE TREAD MODEL  
Part No. 400800



# OCEAN BLUE FOUR TREAD STEPS

For Above Ground Pools Model No. 400700 - Four Tread

ASSEMBLY INSTRUCTIONS - PLEASE READ BEFORE ATTEMPTING ASSEMBLY

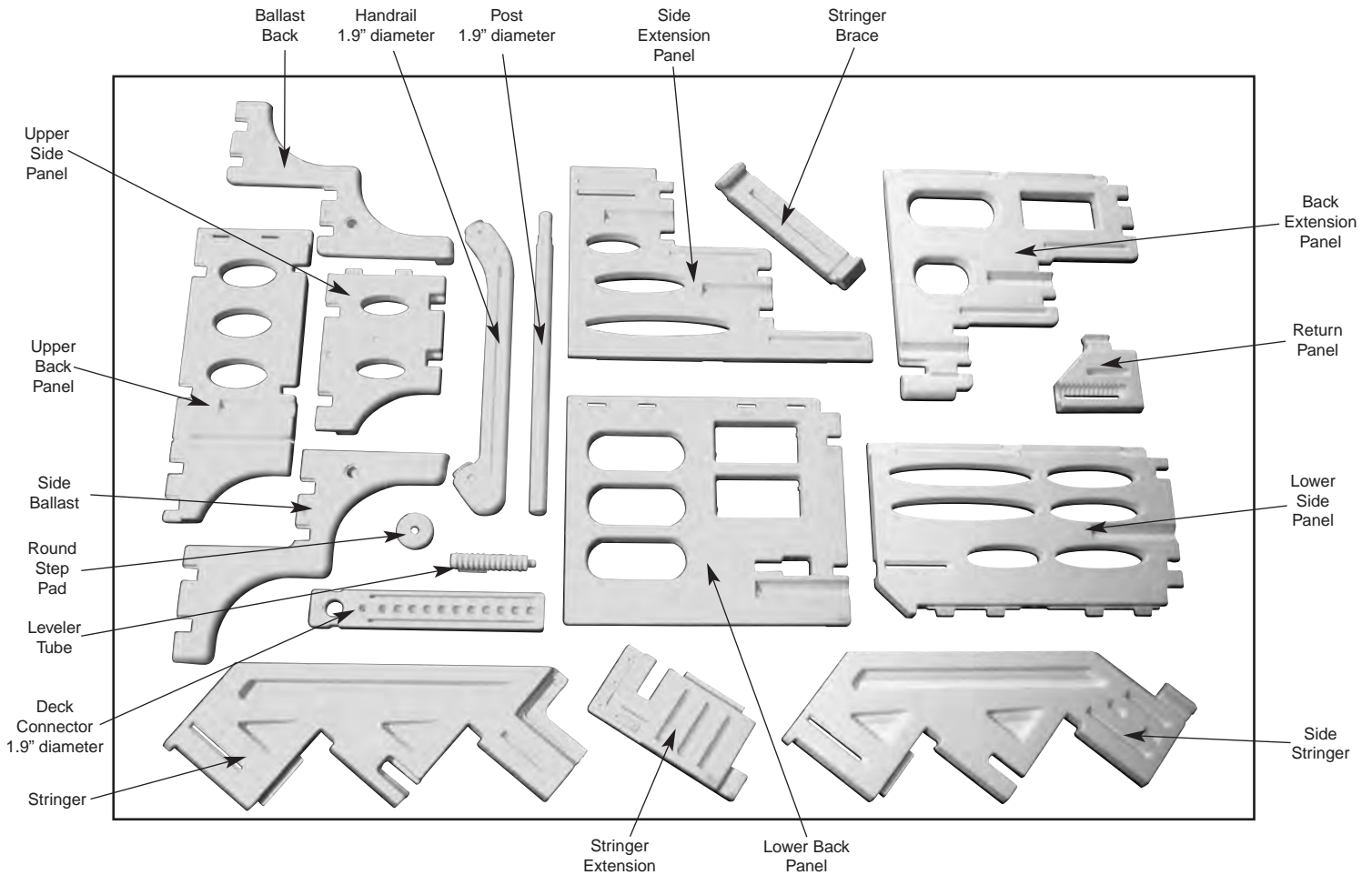

QTY	PART NUMBER	DESCRIPTION
1 -	490709	stringer
1 -	490710	stringer extension
1 -	490712	side stringer
1 -	490711	stringer brace
1 -	490704	lower back panel
1 -	490703	upper back panel
1 -	490707	back extension panel
1 -	490706	lower side panel
1 -	490705	upper side panel
1 -	490708	side extension panel
1 -	490713	return panel
1 -	490716	side ballast
1 -	490717	back ballast
2 -	490700	hand rail 1.9" diameter
4 -	490701	post 1.9" diameter
2 -	490702	deck connector 1.9" diameter
3 -	490714	leveler tube
5 -	490715	round step pad
1 -	490725	left bottom tread
1 -	490726	center bottom tread
1 -	490727	right bottom tread
1 -	490728	second tread
1 -	490729	third tread
1 -	490730	fourth tread

QTY	PART NUMBER	DESCRIPTION
1 -	490721	flexible bottom riser
1 -	490722	flexible second riser
1 -	490723	flexible third riser
1 -	490724	flexible fourth riser
1 -	<b>490731</b>	<b>step hardware/safety pack</b>
<b>29 -</b>		<b>#10 x 1-1/4" self tapping screws</b>
<b>4 -</b>		<b>white plugs</b>
<b>2 -</b>		<b>safety labels</b>
<b>2 -</b>		<b>tread plugs</b>

### Tools Needed for Assembly

- Cordless drill with Phillips head
- Rubber Mallet
- Hack saw (for 3-tread only)
- Plastic funnel
- Liquid soad

**70 LBS. SAND REQUIRED**

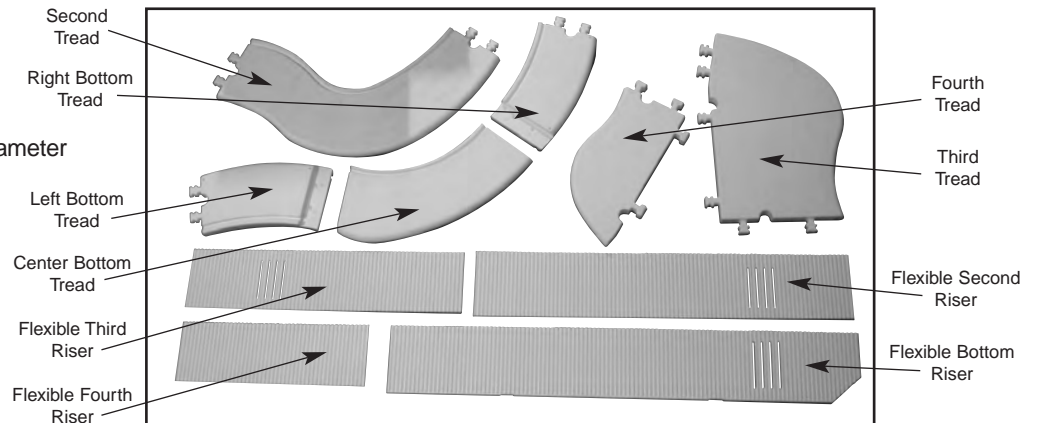

# OCEAN BLUE THREE TREAD STEPS

For In Ground Pools Model No. 400800 - Three Tread

ASSEMBLY INSTRUCTIONS - PLEASE READ BEFORE ATTEMPTING ASSEMBLY

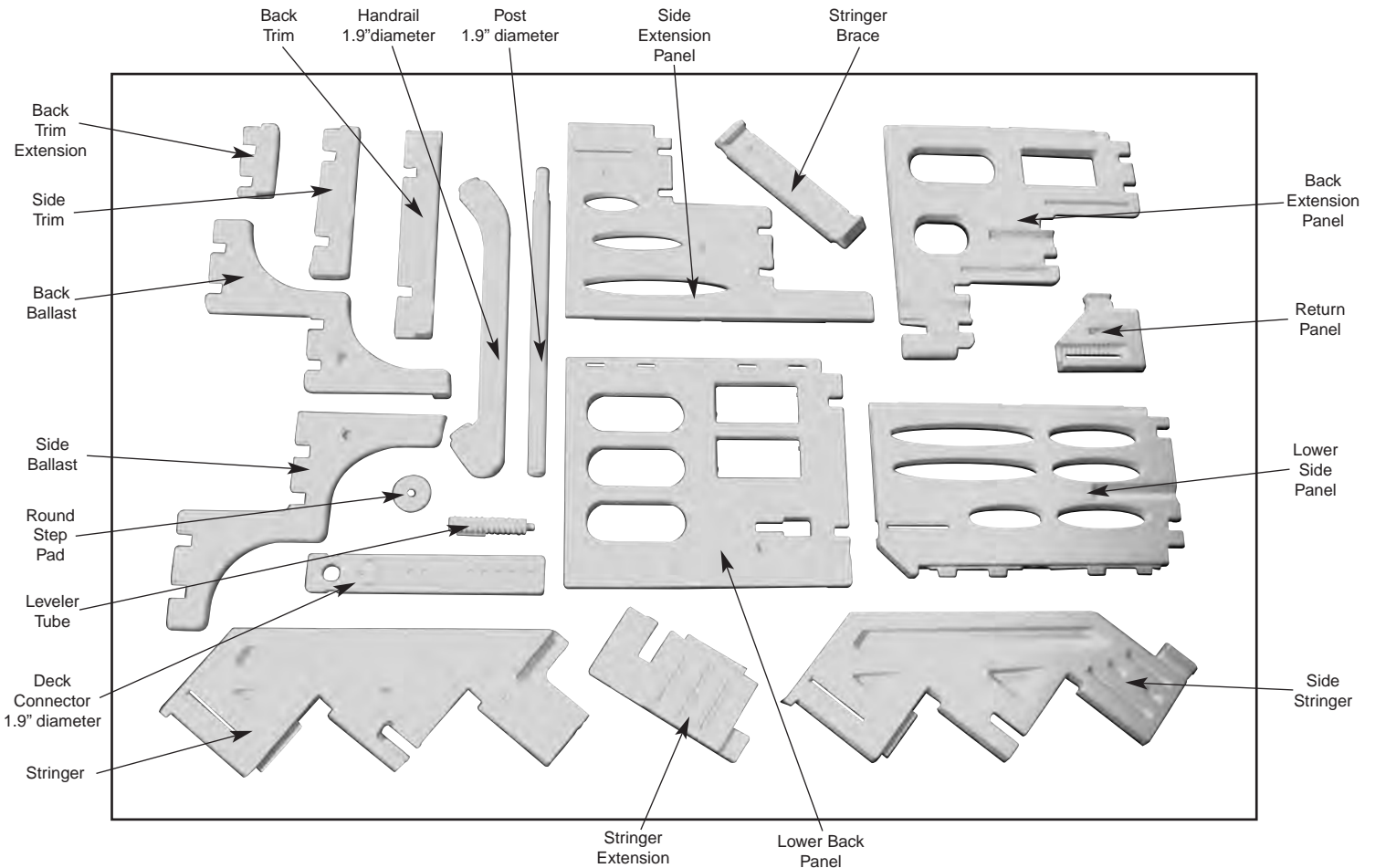

QTY	PART NUMBER	DESCRIPTION
1 -	490709	stringer
1 -	490710	stringer extension
1 -	490712	side stringer
1 -	490711	stringer brace
1 -	490704	lower back panel
1 -	490719	back trim
1 -	490720	back trim extension
1 -	490707	back extension panel
1 -	490706	lower side panel
1 -	490718	side trim
1 -	490708	side extension panel
1 -	490713	return panel
1 -	490716	side ballast
1 -	490717	back ballast
2 -	490700	hand rail 1.9" diameter
4 -	490701	post 1.9" diameter
2 -	490702	deck connector 1.9" diameter
3 -	490714	leveler tube
5 -	490715	round step pad
1 -	490725	left bottom tread
1 -	490726	center bottom tread
1 -	490727	right bottom tread
1 -	490728	second tread
1 -	490729	third tread

QTY	PART NUMBER	DESCRIPTION
1 -	490721	flexible bottom riser
1 -	490722	flexible second riser
1 -	490723	flexible third riser
1 -	<b>490731</b>	<b>step hardware/safety pack</b>
<b>29 -</b>		<b>#10 x 1-1/4" self tapping screws</b>
<b>4 -</b>		<b>white plugs</b>
<b>2 -</b>		<b>safety labels</b>
<b>2 -</b>		<b>tread plugs</b>

**Tools Needed for Assembly**  
 Cordless drill with Phillips head  
 Rubber Mallet  
 Hack saw (for 3-tread only)  
 Plastic funnel  
 Liquid soad  
**70 LBS. SAND REQUIRED**

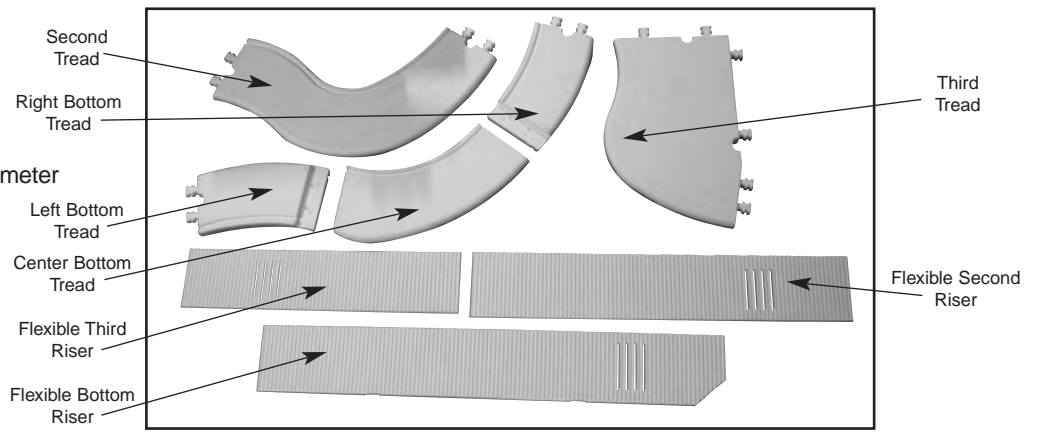

# STEP 1:

**Tools needed:** cordless drill with Phillips driver, rubber mallet  
**Parts needed:** 3-leveler tubes, 5-round step pads, back panel, side panel, back extension, side extension, back extension return, stringer, stringer extension, side stringer and stringer brace

## (FOR ABOVE AND IN GROUND STEPS)



**#1:** Using a rubber mallet install three of the round step pads on to three of the leveler tubes. **A little liquid soap on the leveler tubes will make assembly easier.** Set the three assemblies and two round step pads aside.

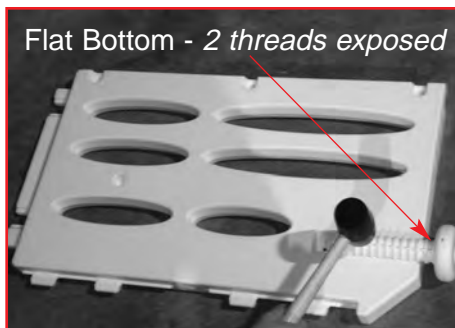

**#2:** Next install one of the leveler tube assemblies into the lower side panel leaving two threads exposed for a flat bottom pool. If pool bottom is tapered install leveler tube all the way up so there are no exposed threads. To install the leveler tube place the long tab on side of tube into slot on panel and tap down with rubber mallet.

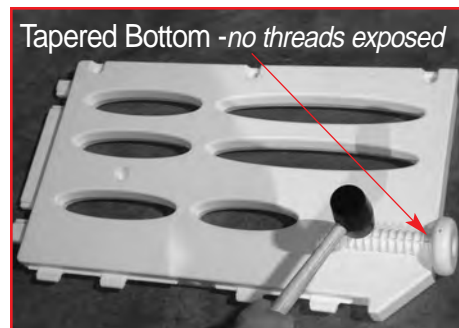

**3:** To make assembly easier apply a little liquid soap onto the four tabs then insert tabs into the openings on the lower back panel and push panels together. Panels are designed to fit together tight, it may require a rubber mallet if panels won't go together by pushing.



**#4:** Install the second leveler tube assembly into the side extension panel. This leveler tube assembly is fixed so there will be no adjustment in the slot on panel.



**#5:** With the assembled panels from step #3 standing up attach the side extension using three #10 x 1-1/4" self tapping screws.



**#6:** Attach the back extension panel using three #10 x 1-1/4" self tapping screws.

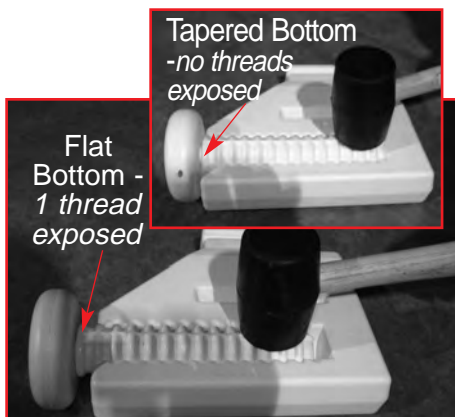

**#7:** Install the third leveler tube assembly into the back extension return leaving one thread exposed for flat bottom pool. If pool bottom is tapered install leveler tube all the way up so there are no exposed threads.



**#8:** Install the back extension return on to the back extension panel. Push down until seated.



# STEP 1: (Cont'd)

(FOR ABOVE AND IN GROUND STEPS)



#9: Turn the assembly over so the lever legs are sitting on the ground.

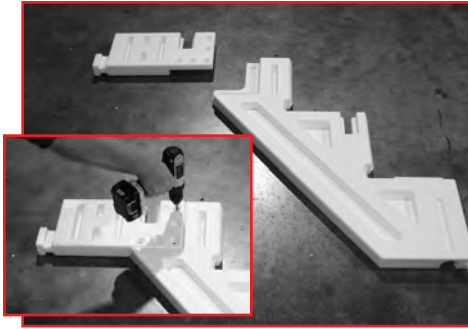

#10: Using three #10 x 1-1/4" self tapping screws one in every other hole attach the stringer extension to the stringer.

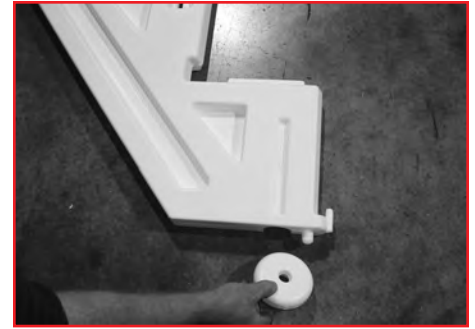

#11: Install one of the round step pads over the round tab located on the bottom of the stringer assembly. **A little liquid soap on the round tab will make assembly easier.**



#12: Insert the stringer assembly into the opening on the back panel and push down until seated.

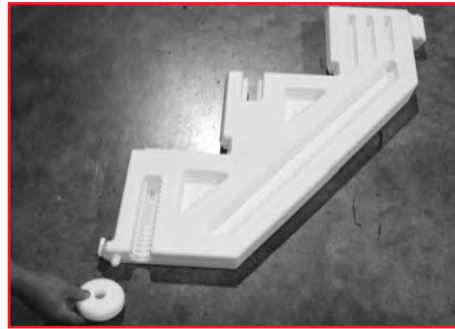

#13: Install the second round step pad over the round tab located on the bottom of the side stringer. **Again, a little liquid soap will make assembly easier.**



#14: Align the tab on the side stringer with the groove on the stringer and push down until seated.



#15: Align the two tabs on the stringer brace with the groove on the stringer and side stringer and push down until seated.

# STEP 2:

## (FOR ABOVE AND IN GROUND STEPS)

**Tools needed:** cordless drill with Phillips driver, rubber mallet  
**Parts needed:** left bottom tread, center bottom tread, right bottom tread, flexible bottom riser, second tread, flexible second riser, third tread, flexible third riser, back ballast, side ballast and 4-white plugs

70 LBS. SAND REQUIRED required for Step 2



**#1:** Position the left bottom tread over the side extension panel and over the raised tab on the stringer. Push down and inward until seated. Attach the tread to the stringer using one of the #10 x 1-1/4" self tapping screws in the outer hole.



**#2:** Next, position the right bottom tread over the back extension and over the raised tab on the side stringer. Push down and inward until seated. Attach the tread to the side stringer using one #10 x 1-1/4 self tapping screw.

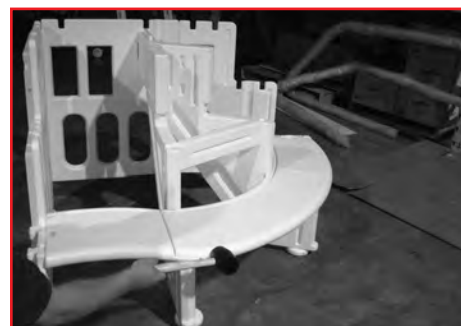

**#3:** Lay the center bottom tread over the right and left bottom treads and push down and inward. The center tread will attach from underneath the step. **Lean the assembly back to expose the bottom of the tread.**



**#4:** Attach the center tread using two #10 x 1-1/4 self tapping screws, one each in the outer holes located on the underside of center step. Screws will install at an angle.



**#5:** With the step assembly still leaning back install the flexible bottom riser by placing over the tabs on the stringers and into the groove on the underside of the bottom tread. The angled cut on the riser will match the angle on the return panel.



**#6:** The flexible riser will only be attached at both ends. Attach at the angled end first by measuring up 2" and over 2" then using a #10 x 1-1/4" self tapping screw go through the face of the riser and in to the return panel. On opposite end measure up 2" and over to the first groove in the riser and angle the screw so it will thread into the raised tab on the panel.

Pour Sand into the Stringer holes



**#7:** At this time pour 25 lbs. of sand into the stringer and 25 lbs of sand into the side stringer. Sand will be added through the holes located at the top of the stringers. As the stringer fills tap the sides to settle sand to the bottom. Plug the two fill holes with two white plugs from the hardware bag **Sand is necessary to keep the steps from floating.**

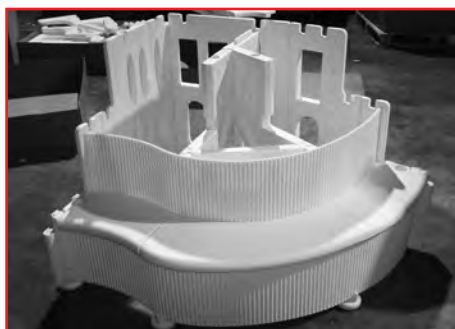

**#8:** Place the second flexible riser into the groove on the bottom tread into the slots on the side extension and back extension. The four ventilation slots in the riser should be positioned on the right side and aligned above the slots in the first riser.



**#9:** Place the second tread over the stringers and onto the side and back extension panels. Align the tabs on one side of the tread with the slots on panel and push down until seated. **Only attach one side of the tread at this time.**

# STEP 2: (Cont'd)

(FOR ABOVE AND IN GROUND STEPS)

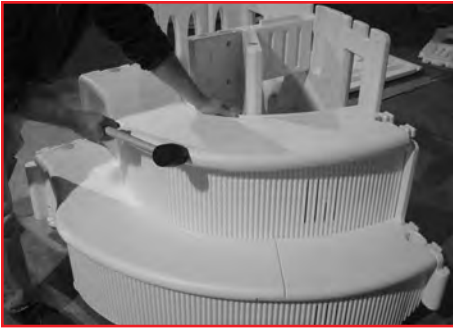

**#10:** Next, push in and downward at the center of tread to lock into the stringers.

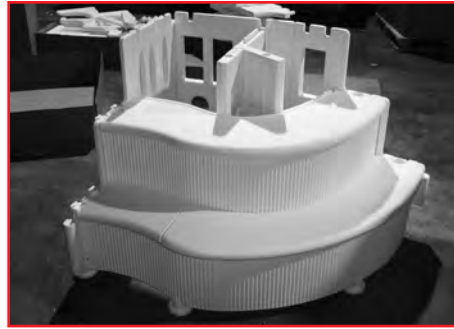

**#11:** Align the tabs on the other side of the tread with the slots on the panel and tap down until seated.

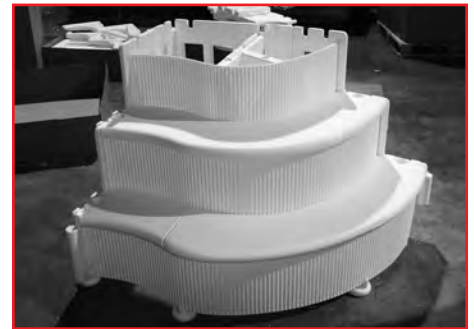

**#12:** Place the third flexible riser in to the groove on the second step and in to the slots on the side and back extensions. The ventilation slots in the riser should be positioned on the right side and aligned above the slots in the first and second risers.



**#13:** Place the third tread over the side and back panels, align the tabs on the tread with the slots on panels and push down until seated.

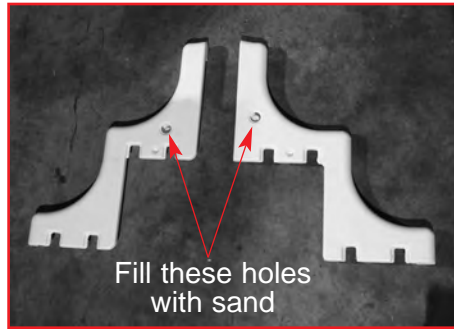

**#14:** Fill the side and back ballast with 10 lbs. of sand each and plug the fill holes using the two white plugs from the hardware bag.



**#15:** Install the side ballast by placing over the side extension panel and pushing down until seated, a mallet may be necessary.



**#16:** Repeat procedure to install the back ballast.

**IF YOU HAVE ABOVE GROUND STEP, SKIP STEP 3 AND GO TO STEP 4**

# STEP 3:

(FOR IN GROUND #400800 STEP ONLY).

**Tools needed:** cordless drill with Phillips driver  
**Parts needed:** 4-posts, 2-handrails, 2-deck connectors  
Side trim, back trim, back trim extension and  
8 -#10 X 1-1/4" self tapping screws

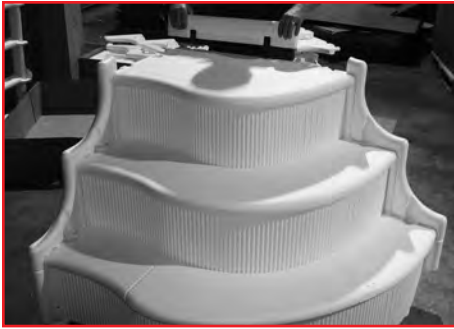

**#1:** Place the back trim over the lower back panel and align the tabs with the slots on panel and push down until seated.



**#2:** Repeat procedure to install the back trim extension and the side trim.



**#3:** Using a hack saw cut 14" off from the bottom ends of two posts. Insert cut posts into both holes located on the second step and push down until posts stop. **A little liquid soap on the posts will make assembly easier.**



**#4:** Insert the other posts into the two holes on third tread and push down until post stops. Using the two plugs from hardware bag, plug the two unused holes on the bottom tread.



**#5:** Slide a deck connector over each of the top posts, **again liquid soap on the posts will make this easier.**



**#6:** Rotate posts to align the flat side with the flat side on the handrail and install both handrails by tapping down with a rubber mallet.



**#7:** Attach the handrail to each post using one #10 x 1-1/4 self tapping screw, repeat for the second hand rail.

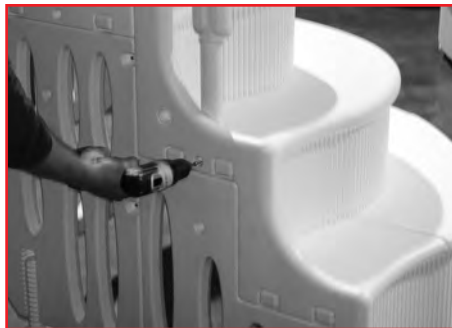

**#8:** Attach all four posts to the step panels using one #10 x 1-1/4 self tapping screw in each post.



**Tools needed:** cordless drill with Phillips driver, rubber mallet  
**Parts needed:** flexible fourth riser, fourth tread, upper side panel, upper back panel, 4 handrail posts, 2 handrails, 2 deck connectors and 10- #10 x 1-1/4 self tapping screws

## STEP 4:

(FOR ABOVE GROUND #400700 STEP ONLY).

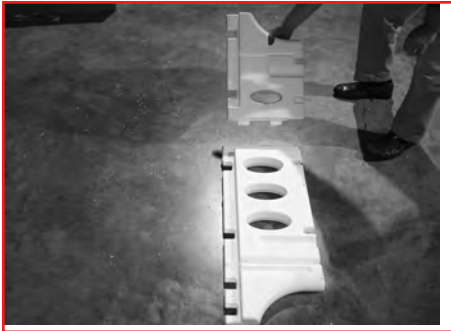

**#1:** Insert the two tabs on the upper side panel in to the openings on the upper back panel and push together. **A little liquid soap on the tabs will make assembly easier.**



**#2:** Position the upper back/side panel assembly over the lower back and side panel, align the tabs with the slots on the panels and push down until seated, mallet may be required.



**#3:** Attach the panel assembly by using one #10 x 1-1/4 self tapping screw in the back panel and one in the side panel at the recesses.

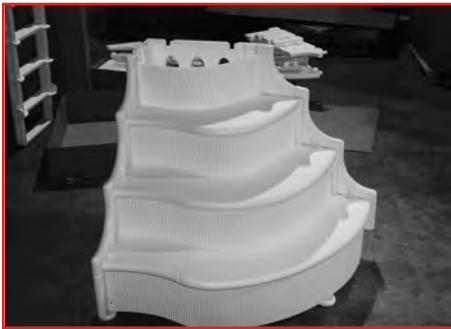

**#4:** Place the fourth flexible riser on top of the third tread with the ends of the riser into the slots on the upper side and back panels. The third tread does not have groove for the riser to set in to.

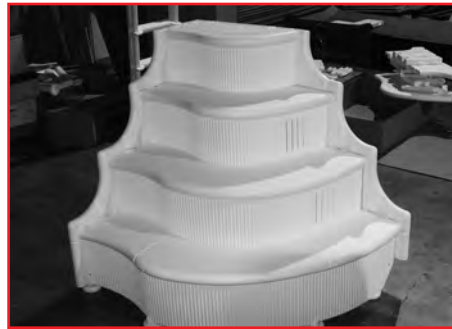

**#5:** Place the fourth tread over the upper side and back panels. Slowly push down making sure to align the top of riser with the groove on the underside of fourth tread.



**#6:** – insert the handrail posts into both holes on the fourth tread and push down until post stops. **A little liquid soap will make assembly easier**

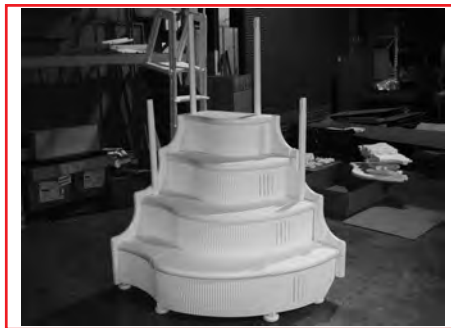

**#7:** Insert the handrail posts into both holes on the second tread and push down until post stops. Using the two plugs from hardware bag, plug the two unused holes on the first tread.



**#8:** Slide a deck connector over each of the top posts. **A little liquid hand soap on the posts will make assembly easier.**



**#9:** Rotate posts to align the flat side with the flat side on the handrail and install both handrails by tapping down with a rubber mallet.

## STEP 4: (Cont'd)

(FOR ABOVE GROUND #400700 STEP ONLY).



**#10:** Attach the handrail to each post using one #10 x 1-1/4" self tapping screw, repeat for the second handrail.



**#11:** Attach all four posts to the step panels using one #10 x 1-1/4" self tapping screw in each post.

## NOTES:

# STEP 5:

**Tools needed:** Cordless drill w/Phillips driver, rubber mallet

**Parts needed:** 6-1-1/4" self tapping screws, 2 safety label

## (FOR ABOVE AND IN GROUND STEPS)

## INSTALLING STEPS INTO SWIMMING POOL

**IT WILL REQUIRE 2-3 PEOPLE TO PLACE STEP INTO POOL.**

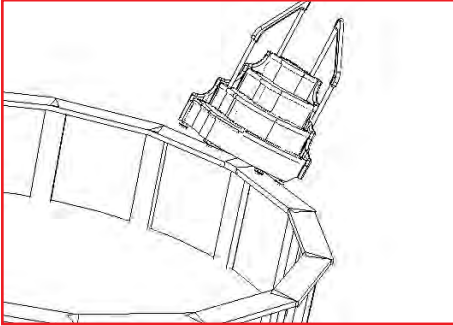

**#1:** Place pool step in the water, if you have an above ground pool be careful not to damage pool frame. Hold the step away from swimming pool wall while it is filling with water.

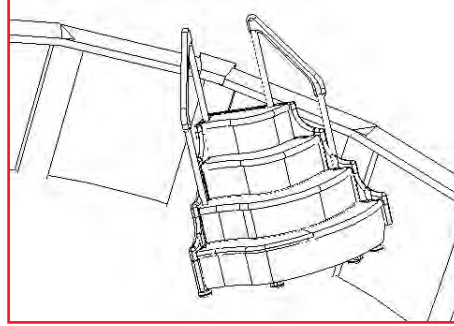

**#2:** Step will float until all the air is out of step components, this will take several minutes. To remove the air, it will be necessary to tilt the step backwards and to the left and right until the air bubbles stop. Once the air bubbles have stopped the step should be sitting firmly on bottom of pool. If not, air is still trapped in components and step will have to be tilted again.

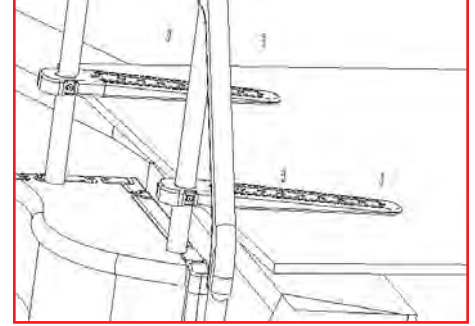

**#3:** Position the step close to the pool wall. Rotate the two deck connectors to sit on to pool deck and attach using two #10 x 1-1/4" self tapping screws in each connector. If you have a concrete deck you will need to purchase the proper fasteners for concrete.

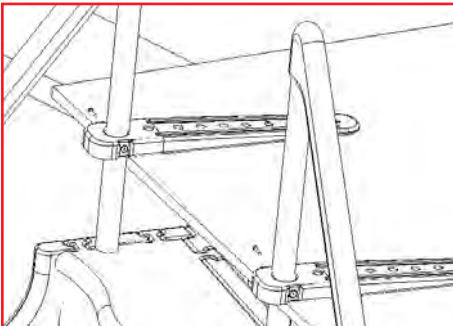

**#4:** Attach the deck connectors to each handrail posts using one #10 x 1-1/4" self tapping screw.



**#5:** Apply the two safety labels on the upper handrail posts so they are visible when entering the swimming pool.

## SAFETY RULES

- One person on the step at a time
- **DANGER:** shallow water no jumping or diving from step or pool deck
- **ALWAYS** have competent adult supervision when pool is in use
- **NEVER** leave the pool unattended
- **NO** unauthorized entry into pool
- To prevent entrapment or drowning step must be installed up to the inside of pool wall
- Weight limit **400 lbs**
- Exceeding the recommended weight limit may cause step to fail

## IMPORTANT FOR YOUR SAFETY

- \* Consult your local building department before installation of your pool and equipment.
- \* Check the contents of the carton with the parts list for this step.
- \* **DO NOT** attempt to assemble or install this step if there are **ANY** shortages of parts or hardware.
- \* For proper assembly and installation follow all instructions in the sequence shown.
- \* Before using the product, after assembly and installation, go over the instructions and procedures again to make sure nothing has been overlooked.
- \* Be sure and safe. The manufacturer **IS NOT** responsible for improper assembly or installation.

**DANGER:** only use a cordless drill for assembly and installation. **NEVER** use a corded electric drill in or around swimming pool.

**WINTERIZING:** Disconnect the step from pool deck or outside safety ladder and carefully lift out of water. Once out of water, tip step on its back to drain water from panels. After drained, tip step on its front to finish draining water. All the water must be drained from step before putting in to storage.

**NOTE: sand remains in step — do not remove sand.**

## OCEAN BLUE WATER PRODUCTS WARRANTY

Ocean Blue Water Products warrants their swimming pool steps to be free from defects in workmanship for one year from date of purchase.

### DO NOT RETURN DEFECTIVE PART TO DEALER

The defective part should be returned, postpaid, to:  
Ocean Blue Water Products  
4646 W. Lake Street  
Chicago, IL 60644

Enclose proof-of-purchase (receipts, etc.) showing date purchased, your name, address, and daytime phone number. You will be notified of cost to replace part.

*This warranty gives you specific legal rights, and you may also have other rights which may vary from state to state.*

Made in U.S.A.



Printed in U.S.A.

01/14/11