

**NE122SS STAINLESS STEEL
IN POOL LADDER**



**ASSEMBLY
AND
INSTALLATION INSTRUCTIONS**

Parts Identification

STEP 1

Unpack box and check parts against parts list below.

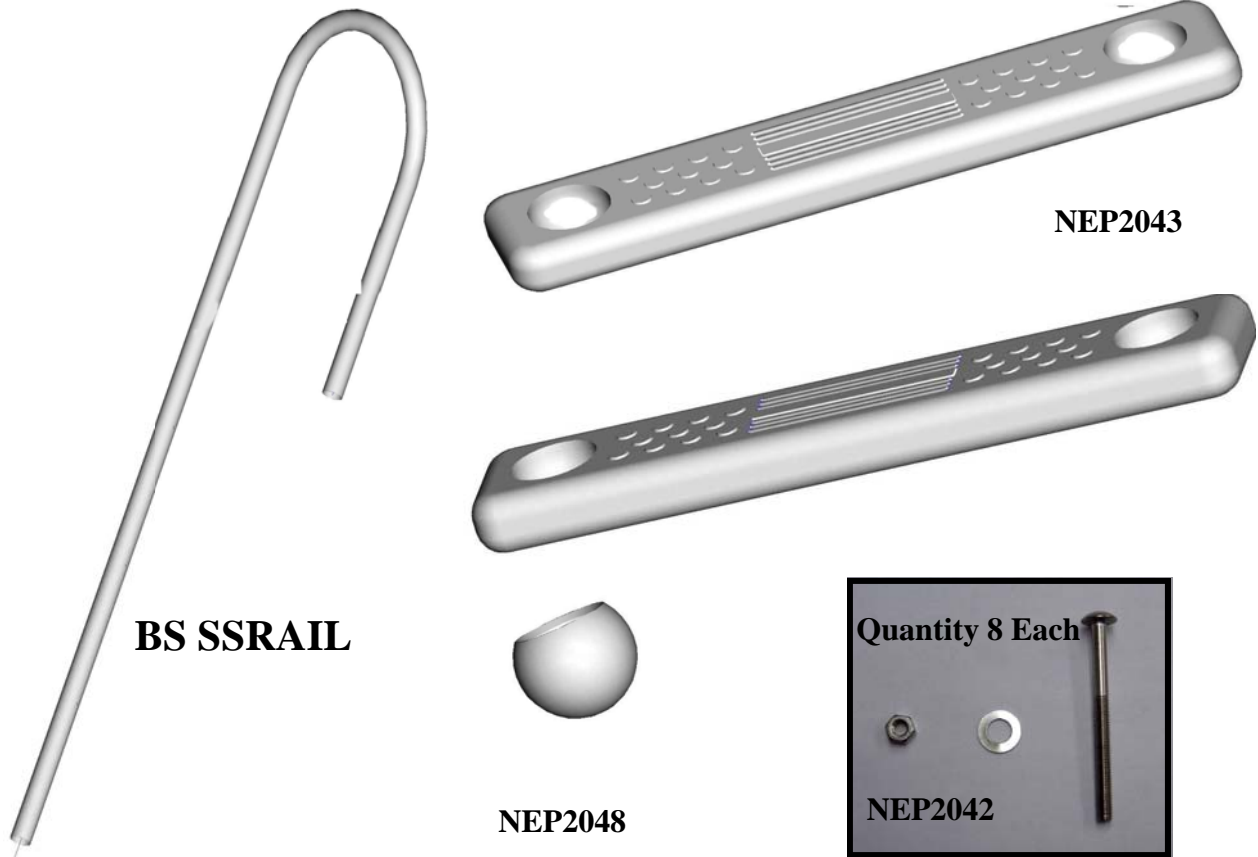

PARTS LIST

<u>QUANTITY</u>	<u>PART #</u>	<u>DESCRIPTION</u>
2	BS SSRAIL	STAINLESS STEEL HAND RAIL
4	NEP2043	LADDER STEPS
2	NEP2048	PIVOT BALLS FOR BASE STEP
1	NEP2044	BOTTOM STEP
1	NEP2042	HARDWARE BAG
2	BS35998	PLASTIC FLANGES-WHITE

STEP 2

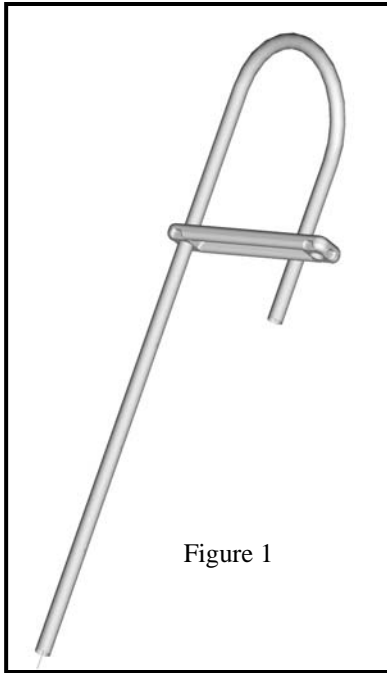

- Slide 1 of the 4 ladder steps onto one of the stainless steel handrails. See figure 1
- Make sure that the step treads are facing up.
- If you have any difficulty sliding the step onto the handrail apply a small amount of oil to the handrail.
- Align the holes in the step with the top set of holes on the handrail.
- Secure step to handrail with a bolt and nut. Make sure that the head of the bolt is located on the outside of the step.

See figure 2

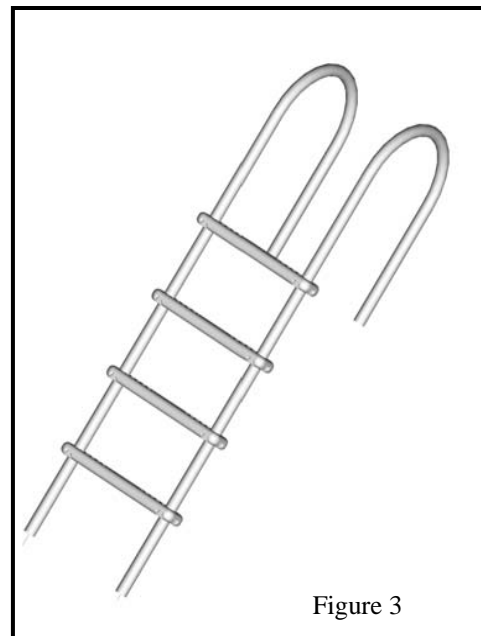
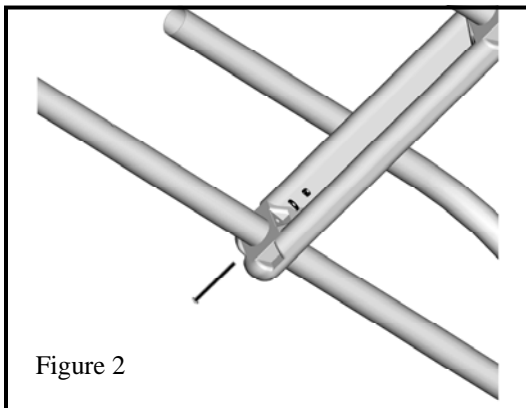

- Slide the second handrail thru the hole on the opposite side of the step. Secure with a nut and bolt. See figure 2
- Slide the remaining 3 steps onto the handrails and secure them with nuts and bolts. See figure 3

STEP 4

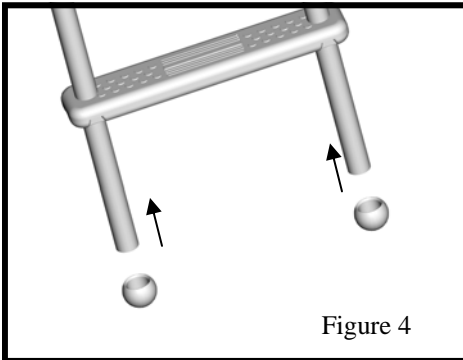

- Slide 1 pivot ball onto the bottom of each handrail
- Make sure both pivot balls are securely fastened to each handrail. See figure 4

STEP 5

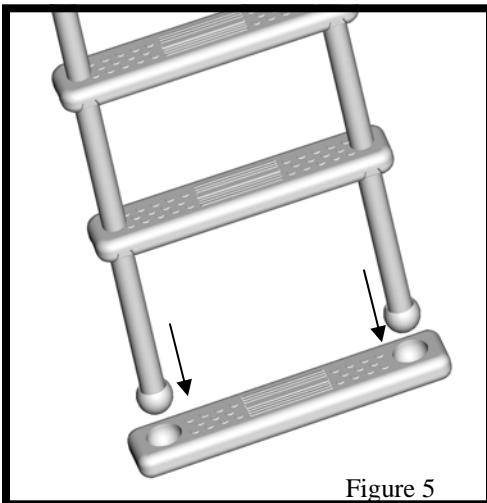

- Place the bottom step on the floor facing up
- Hold the ladder assembly straight up and align the pivot balls with the receivers on the bottom step.
- Push down firmly until both balls are inserted into the step. See figure 5

STEP 6

Ladder Placement - Figure 6

- Locate ladder in desired position on deck. (A)
- Make sure base step rests flat against the pool floor. Swivel step if needed to align with pool floor. (B)
- Mark location of handrails on deck with a pencil.
- Using a 1 1/2" hole saw, drill 1 hole for each hand rail through deck surface. (C)
This will ensure that the deck will now support the ladder.
- Secure hand rails to deck using deck flanges (D)
Slide flanges over each hand rail, insert handrails through the holes in the deck. Secure flanges to deck with screws. Secure flange to handrail using set screw.

