

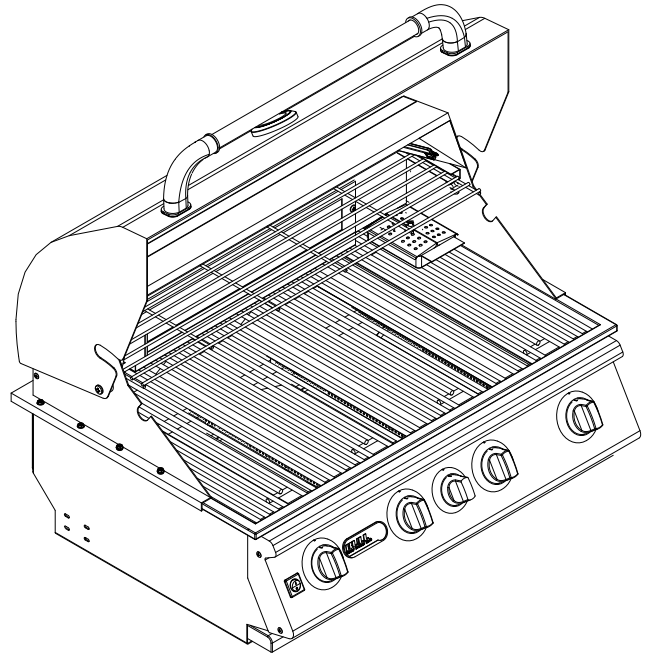

ANGUS GRILL

SPEC SHEET

*ISLAND MUST BE CONSTRUCTED WITH NON-COMBUSTIBLE MATERIALS; REFER TO GRILL OWNERS MANUAL



ISOMETRIC VIEW

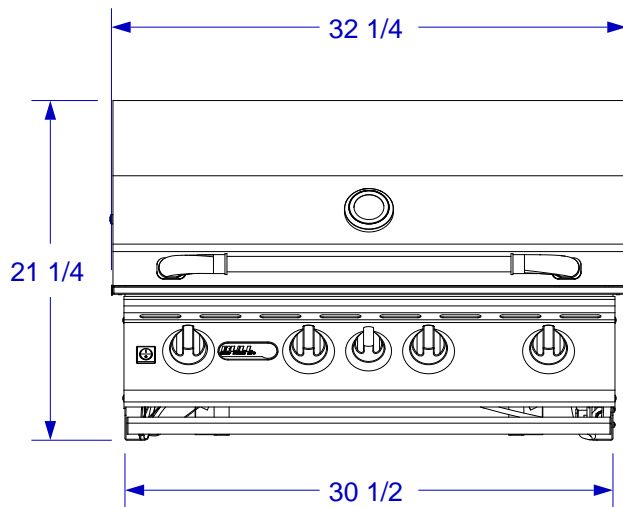

FRONT VIEW

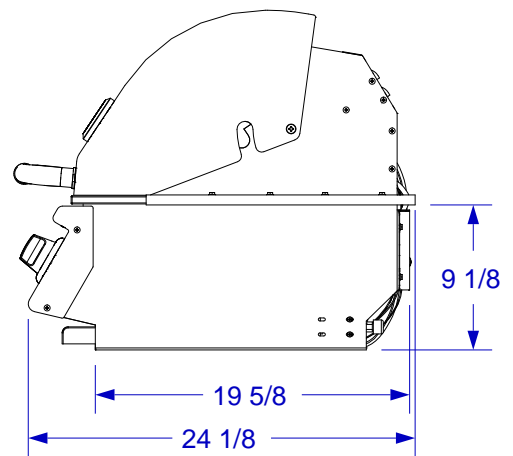

RIGHT SIDE VIEW

NOTES:

1. CUTOUT DIMENSIONS: 31" W X 21" L X 10" D
2. SCALE: 1" = 1'-0"
3. REVISION: 01/2012