

POOL BREAKDOWN

COASTLINE 18' ROUND 48"

STEEL TOP RAIL - STEEL VERTICAL

√	QTY	CARTON NUMBER	CARTON DESCRIPTION
	1	5-9918-106	ASSEMBLY PACK CARTON
	1	5-9715-505	VERTICAL PACK CARTON
	1	5-0564-018	SIDEWALL CARTON



CARTON BREAKDOWN

✓	ITEM	QTY	PART NUMBER	DESCRIPTION
ASSEMBLY PACK # 5-9918-106				
	1	31	545-1001	Plastic coping
	2	12	580-2379	Vertical end cap
	3	9	583-1011	Stabilizer Rail (Large)
	4	9	583-1012	Stabilizer Rail (Small)
	5	12	589-1299	Bottom rail
	6	12	580-1344	Bottom connector
	7	12	340-2139	Top connector
	8	108	330-1127	Sheet metal screw, #10 x 1/2"
	18	12	587-1351	Top Rail
	—	1	573-3908	Pool Parts List
	—	1	573-3715	Installation Instructions
	—	1	— — —	Warranty Card
	—	1	573-3169	"Safety First" Booklet

VERTICAL PACK # 5-9715-505				
	19	12	580-1945	Vertical

SIDEWALL CARTON # 5-0564-018				
	20	1	5-0564-018	Sidewall
	21	1	535-1442	Protective Strip
	22	25	321-1029	1/4-20 Hex Flange Locknut
	23	25	330-1280	1/4-20 x 1/2" Grade 5 Bolt
	—	1	560-1055	Warning Sign
	—	1	573-3169	"Safety First" Booklet
	—	1	573-3498	Safety DVD

EXPLODED PARTS VIEW

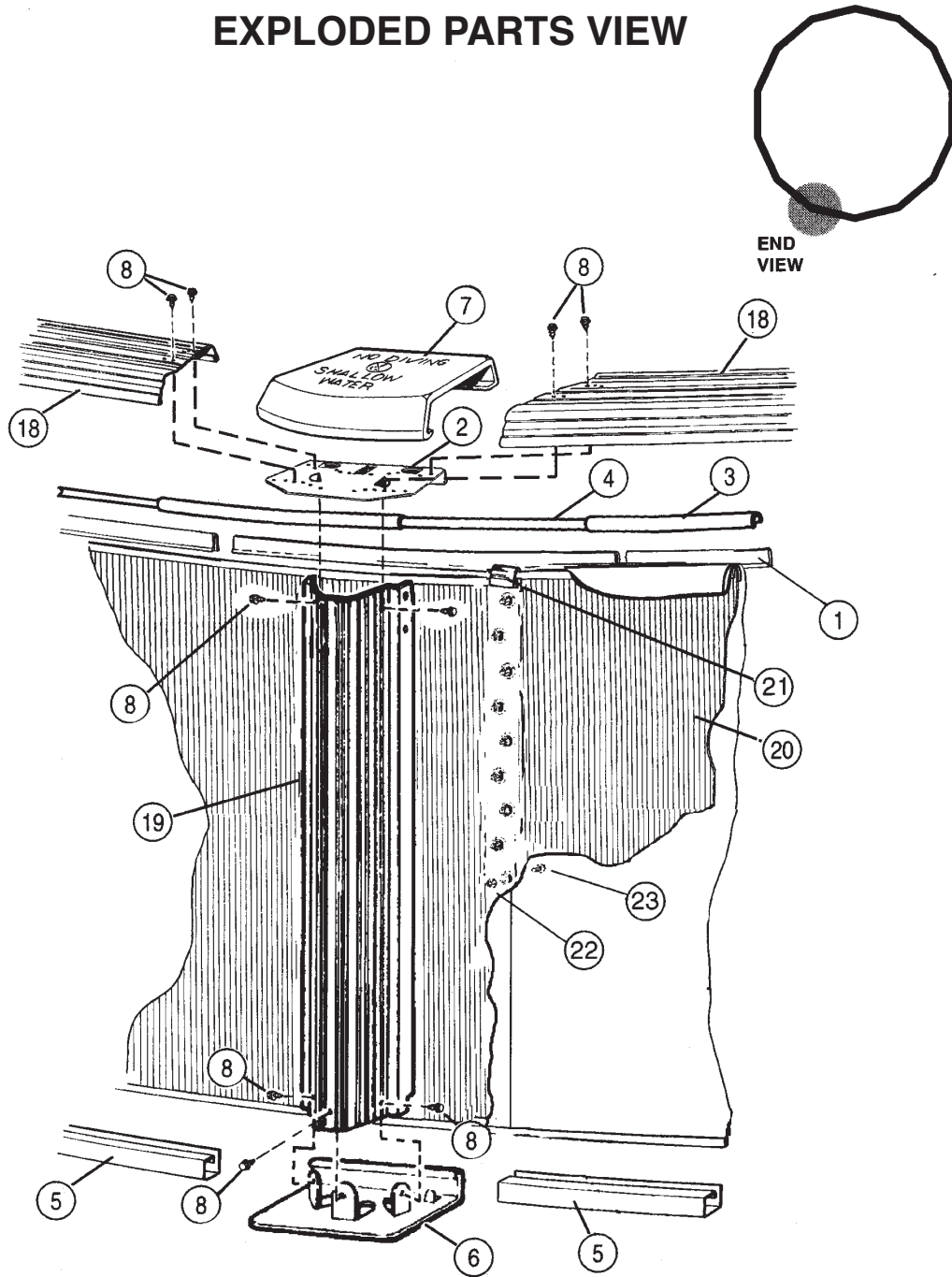

Important! Above-ground pools are designed for swimming and wading only. Do not Dive or Jump! Misuse of your pool may result in crippling injury and/or other dangers to life and health. Do not use slides, diving boards, or any other platform or object which can be used for improper pool entry. Use only an above-ground swimming pool ladder or entry system to enter or exit your pool. Never attempt to swim or reach behind ladders or any other pool entry system. It is the pool owner's responsibility to secure the pool against unauthorized, unsupervised or unintentional entry. It is also the pool owner's responsibility to warn all pool users of the hazards of diving into shallow water: paralyzing injury may result. Always obey all safety rules. Remember, pool safety is everybody's responsibility.

Safety decals and caution information provided with your pool have been endorsed by the U.S. Consumer Product Safety Commission. It is mandatory that the pool owner and installer follow the installation and use directions for all provided safety signs and decals. Juveniles must be supervised at all times by a responsible adult as directed by the USCPSC.

Change of Design: The manufacturer (Hill) expressly reserves the right to change or modify the design and construction of any product in due course of their manufacturing procedures, without incurring any obligation to furnish or install such changes or modifications on products previously or subsequently sold.