



# POOL BREAKDOWN

## WHISPERING WIND 30' ROUND 52" STEEL TOP RAIL - STEEL VERTICAL

√	QTY	CARTON NUMBER	CARTON DESCRIPTION
	1	1-3052-901-819	ASSEMBLY PACK CARTON
	1	1-3000-904-806	VERTICAL PACK CARTON
	1	1-2203-905-816	TOP RAIL PACK CARTON
	1	1-2200-903-816	TOP CONNECTOR PACK
	1	1-3052-906-209	SIDEWALL CARTON



# CARTON BREAKDOWN

✓	ITEM	QTY	PART NUMBER	DESCRIPTION
<b>ASSEMBLY PACK # 1-3052-901-819</b>				
	2	14	583-1005	Stabilizer Rail (Large)
	3	14	583-1004	Stabilizer Rail (Small)
	4	22	580-2087	Vertical center section
	5	44	580-2260	Vertical end cap
	7	47	545-1001	Plastic coping
	8	22	589-1139	Bottom rail
	18	220	330-1127	Sheet metal screw, #10 x 1/2"
	—	1	573-4505	Pool Parts List
	—	1	573-3656	Installation Instructions
	—	1	— — —	Warranty Card
	—	1	573-3169	"Safety First" Booklet

<b>TOP RAIL PACK # 1-2203-905-816</b>				
	1	22	587-1411	Top Rail

<b>TOP CONNECTOR PACK # 1-2200-903-816</b>				
	6	22	340-2220	Top connector

<b>VERTICAL PACK # 1-3000-904-806</b>				
	19	44	580-2088	Vertical

<b>SIDEWALL CARTON</b>				
	30	1	1-3052-906-209	Sidewall
	31	1	535-1442	Protective Strip
	32	27	321-1029	1/4-20 Hex Flange Locknut
	33	27	330-1280	1/4-20 x 1/2" Grade 5 Bolt
	—	1	560-1055	Warning Sign
	—	1	573-3169	"Safety First" Booklet
	—	1	573-3498	Safety DVD

WRITE SIDEWALL NUMBER HERE \_\_\_\_\_

WRITE SIDEWALL BOX SERIAL NUMBER HERE \_\_\_\_\_

# EXPLODED PARTS VIEW

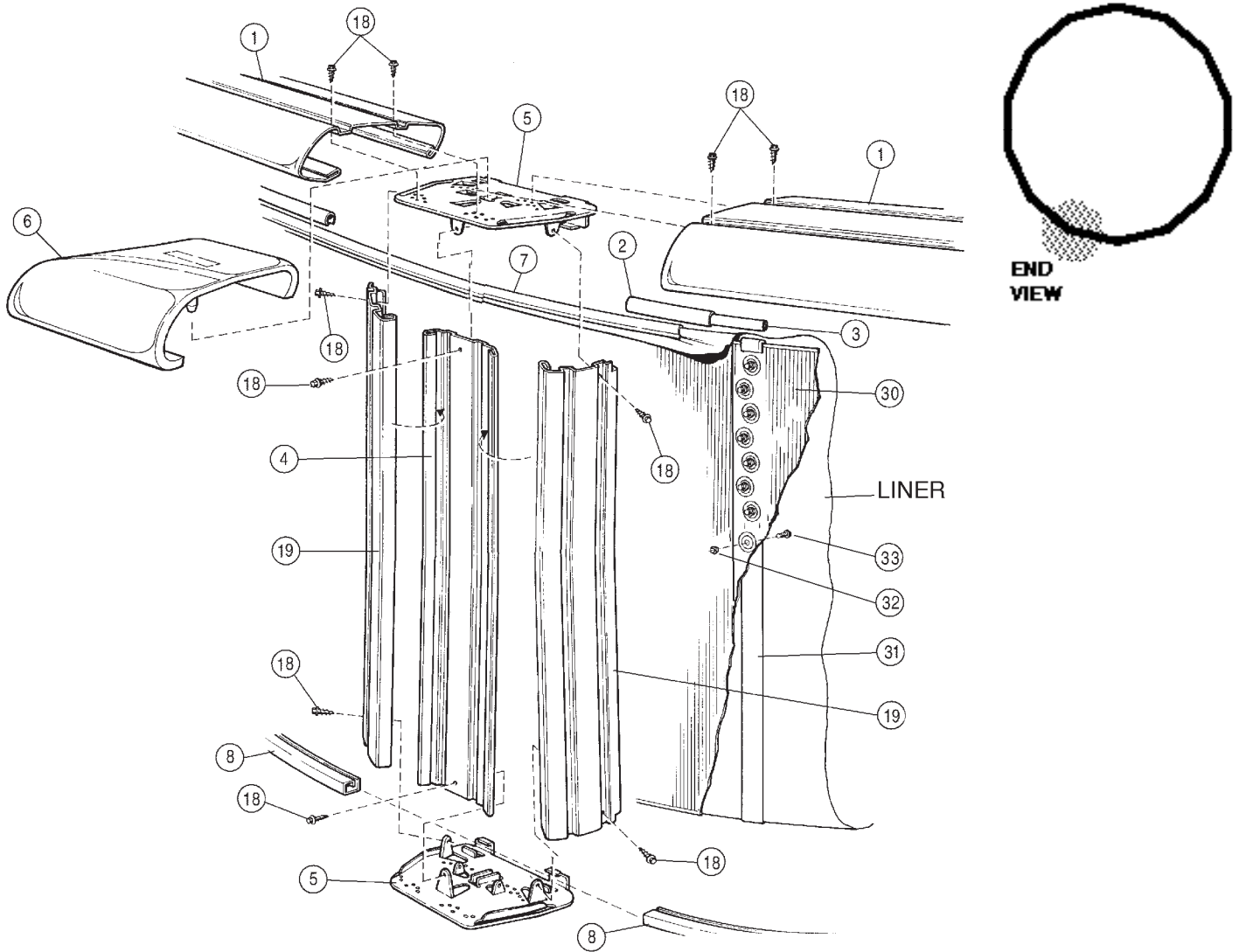

**Important!** Above-ground pools are designed for swimming and wading only. Do not Dive or Jump! Misuse of your pool may result in crippling injury and/or other dangers to life and health. Do not use slides, diving boards, or any other platform or object which can be used for improper pool entry. Use only an above-ground swimming pool ladder or entry system to enter or exit your pool. Never attempt to swim or reach behind ladders or any other pool entry system. It is the pool owner's responsibility to secure the pool against unauthorized, unsupervised or unintentional entry. It is also the pool owner's responsibility to warn all pool users of the hazards of diving into shallow water: paralyzing injury may result. Always obey all safety rules. Remember, pool safety is everybody's responsibility.

Safety decals and caution information provided with your pool have been endorsed by the U.S. Consumer Product Safety Commission. It is mandatory that the pool owner and installer follow the installation and use directions for all provided safety signs and decals. Juveniles must be supervised at all times by a responsible adult as directed by the USCPSC.

Change of Design: The manufacturer (Hill) expressly reserves the right to change or modify the design and construction of any product in due course of their manufacturing procedures, without incurring any obligation to furnish or install such changes or modifications on products previously or subsequently sold.