



ROYAL
SWIMMING POOLS

Pool Size: 16' X 36'
Pool Shape: RECTANGLE
Pool Number: 1636RECT2R-8D
Pool Codes: ----

6426 Summer Gale Dr. Memphis, TN 38134 | 866-532-8194 | fax: 888-977-2846 | Support@RoyalSwimmingPools.com

FINISHED POOL DIMENSIONS (WITH 2" POOL BASE) SHOWN.
SEE MANUAL FOR EXCAVATION INSTRUCTIONS.

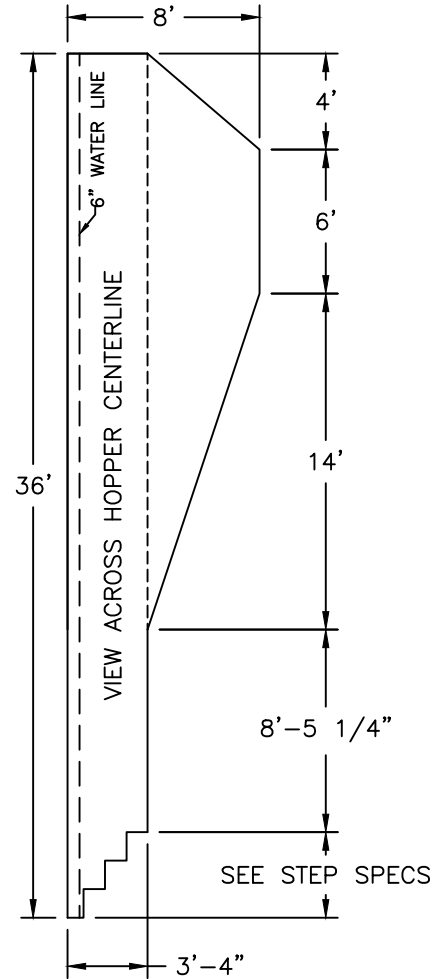
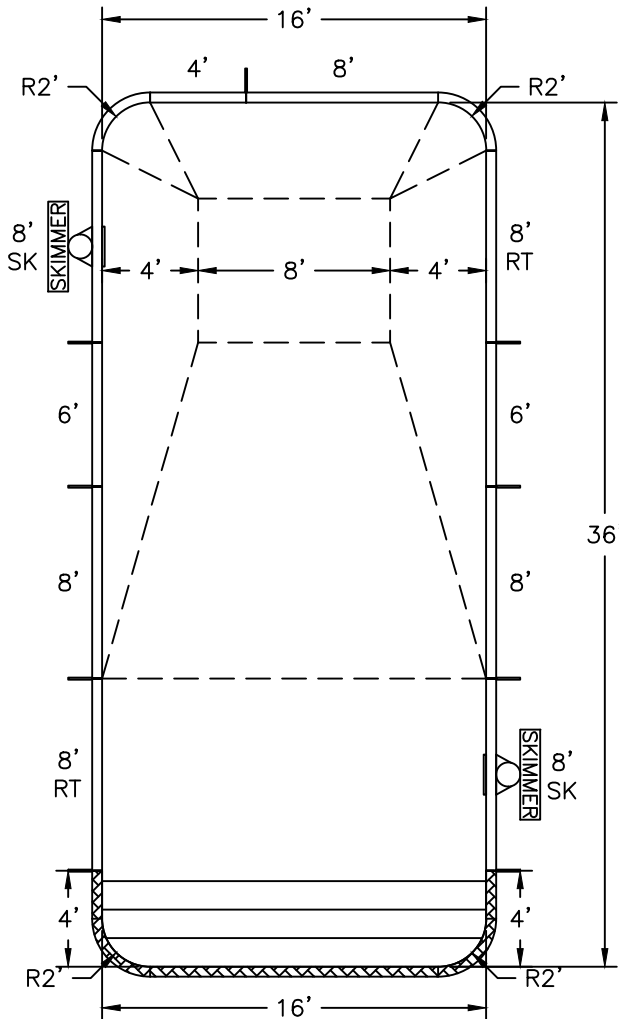

16' X 42" X 2R FULL
WIDTH STEEL STEP
CFWMOD-1642-2R

Date: 02/21/2022

Perimeter: 100'-6 3/4"

Drawn By: MH

Area: 572.6 SQ. FT.

Scale: 1/8" = 1'-0"

Notes: Royal Swimming Pools

Signature:

DRAWING APPROVAL IS FINAL: NO FURTHER CHANGES MAY BE MADE TO YOUR DRAWING.



ROYAL
SWIMMING POOLS

Name: 16' X 42" X 2R FULL WIDTH STEP – CARDINAL MODULAR

Number: CFWMOD-1642-2R

6426 Summer Gale Dr. Memphis, TN 38134 | 866-532-8194 | fax: 888-977-2846 | Support@RoyalSwimmingPools.com

BOM		
REF.	VENDOR SKU #	QTY
A	2RADSTMODLTS	1
B	2RADSTMODRTS	1
C	2FTSTMODSECS	1
D	8FTSTMODSECS	1

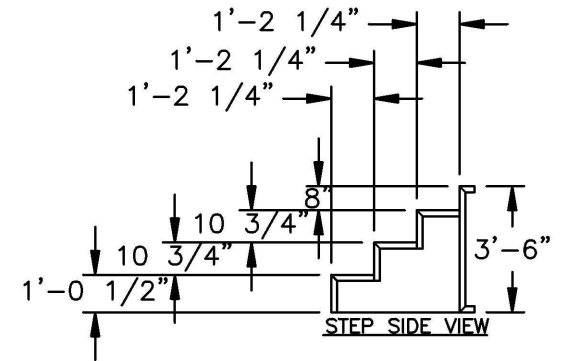
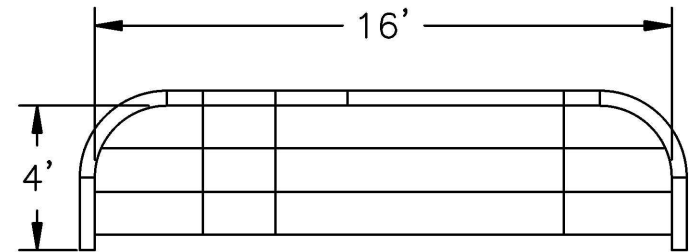
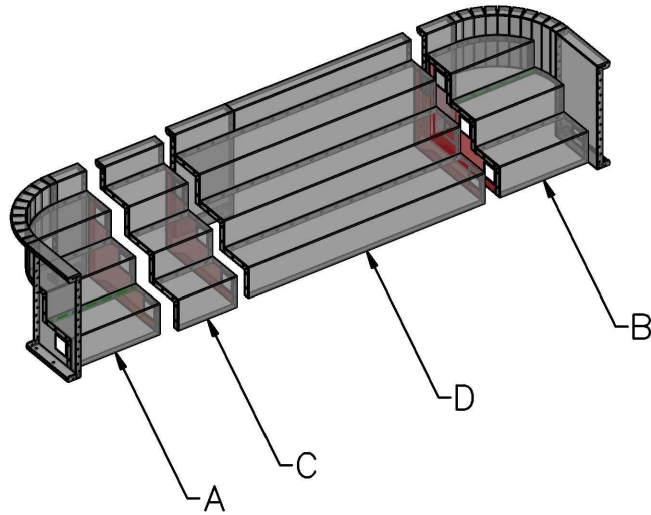

Drawn By: GR

Date: 2/15/2021

Scale: 3/16" = 1'-0"

Notes: -----



Name: 3'-0" LEFT SIDE 2' RADIUS MODULAR STEEL STEP

Number: 2RADSTMODLTS

250 Route 61 South, Schuylkill Haven, PA 17972 • 570-385-4733 • fax: 570-385-1318 • CustomerService@CardinalSystemsinc.com

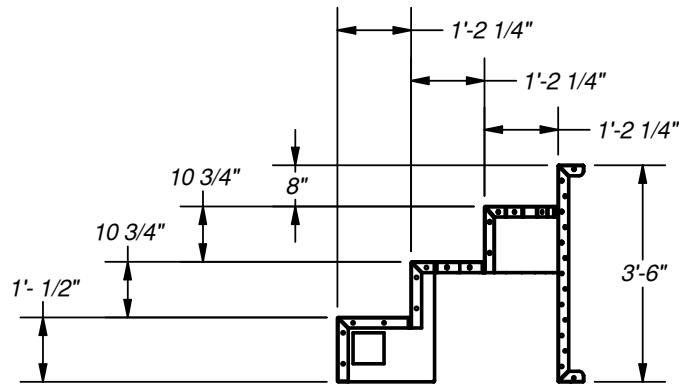
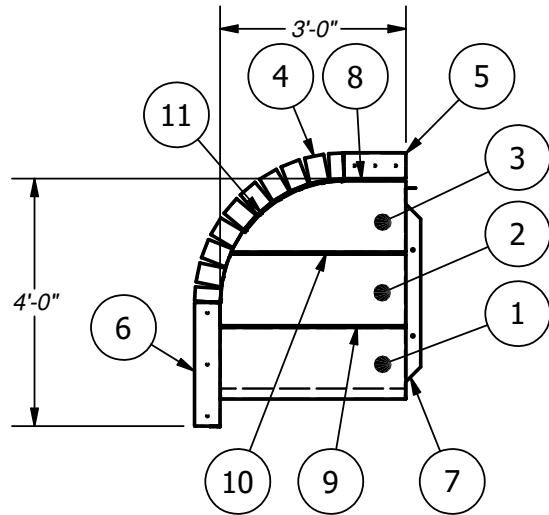

TREAD SECTION
SCALE 1 / 35

PARTS LIST			
ITEM	PART NUMBER	QTY	DESCRIPTION
1	BT1143	1	3'-0" BOTTOM TREAD
2	TD03398	1	3'-0" TREAD
3	TD03390	1	2'-9 7/8" TREAD
4	SR00539	1	3'-1 3/4" X 2'-0" RADIUS STEP RISER
5	SP06888	1	1'-0" STEP PANEL
6	SP0251	1	2'-0" STEP PANEL
7	TS0069	1	3'-6" TREAD SUPPORT
8	LT0028	1	1'-0" LINER TRACK
9	LT0031	1	3'-0" LINER TRACK
10	LT0064	1	2'-9 3/4" LINER TRACK
11	LT03123	1	1'-10 3/4" X 2'-0" RADIUS LINER TRACK
12	BP106ST	1	LARGE STEP BOLT PACK

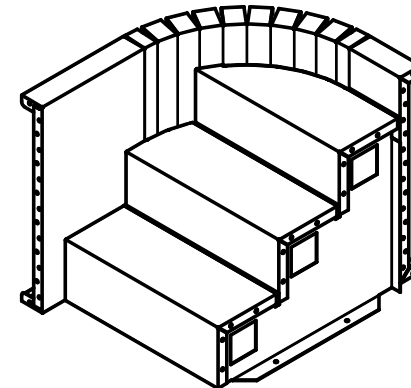

NOTE:
USE REBAR HOLE LOCATIONS TO PIN WALL AND STEP DECK SUPPORTS IN PLACE. THEN POUR 4"-6" OF CONCRETE AROUND THESE AREAS AND UNDER THE ASSEMBLY FOR REINFORCEMENT

Drawn By: Shay

Date: 7/18/2019

Scale: 1 : 35

Notes: ST012166

This information is the confidential property of Cardinal Systems, Inc. Disclosure or duplication without proper written approval is strictly prohibited. Acceptance and use of this drawing constitutes knowledge and acceptance by the user of the terms and conditions set forth in the notice and warning which accompanied this drawing is incorporated herein and made part hereof and is found on Cardinal Systems, Inc's website at www.CardinalSystemsinc.com



CardinalSystemsinc.com



Name: 3'-0" RIGHT SIDE 2' RADIUS MODULAR STEEL STEP

Number: 2RADSTMODRTS

250 Route 61 South, Schuylkill Haven, PA 17972 • 570-385-4733 • fax: 570-385-1318 • CustomerService@CardinalSystemsinc.com

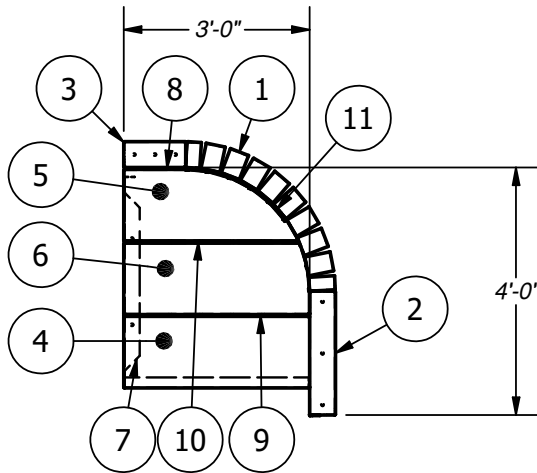

PARTS LIST			
ITEM	PART NUMBER	QTY	DESCRIPTION
1	SR00540	1	3'-1 3/4" X 2'-0" RADIUS STEP RISER
2	SP0252	1	2'-0" STEP PANEL
3	SP06888	1	1'-0" STEP PANEL
4	BT1143	1	3'-0" BOTTOM TREAD
5	TD03393	1	2'-9 7/8" TREAD
6	TD03399	1	3'-0" TREAD
7	TS0069	1	3'-6" TREAD SUPPORT
8	LT0028	1	1'-0" LINER TRACK
9	LT0031	1	3'-0" LINER TRACK
10	LT0064	1	2'-9 3/4" LINER TRACK
11	LT03123	1	1'-10 3/4" X 2'-0" RADIUS LINER TRACK
12	BP106ST	1	LARGE STEP BOLT PACK

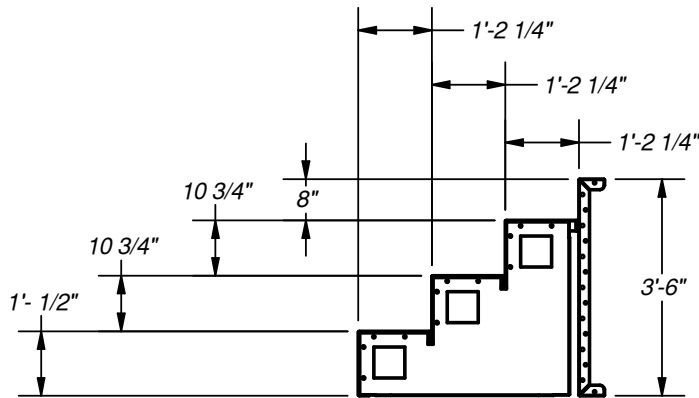

TREAD SECTION
SCALE 1 / 35

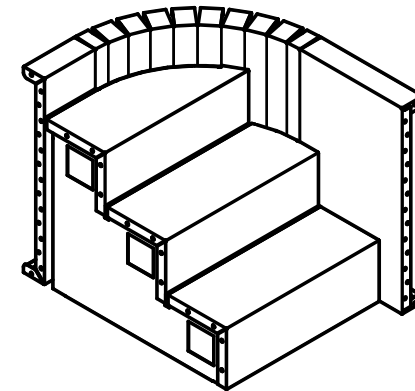

NOTE:
USE REBAR HOLE LOCATIONS TO PIN WALL AND STEP DECK SUPPORTS IN PLACE. THEN POUR 4"-6" OF CONCRETE AROUND THESE AREAS AND UNDER THE ASSEMBLY FOR REINFORCEMENT

Drawn By: Shay Date: 7/18/2019

Scale: 1 : 35 Notes: ST012171

This information is the confidential property of Cardinal Systems, Inc. Disclosure or duplication without proper written approval is strictly prohibited. Acceptance and use of this drawing constitutes knowledge and acceptance by the user of the terms and conditions set forth in the notice and warning which accompanied this drawing is incorporated herein and made part hereof and is found on Cardinal Systems, Inc's website at www.CardinalSystemsinc.com



CardinalSystemsinc.com



Name: 2'-0" STEEL MODULAR STEP SECTION (1'-2 1/4" TREADS)

Number: 2FTSTMODSECS

250 Route 61 South, Schuylkill Haven, PA 17972 • 570-385-4733 • fax: 570-385-1318 • CustomerService@CardinalSystemsinc.com

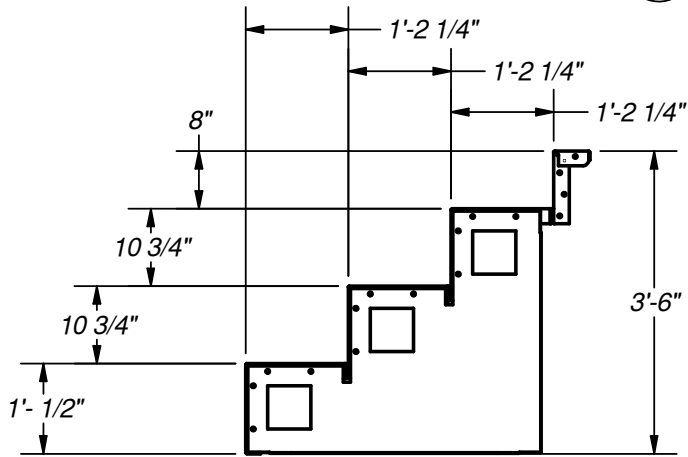
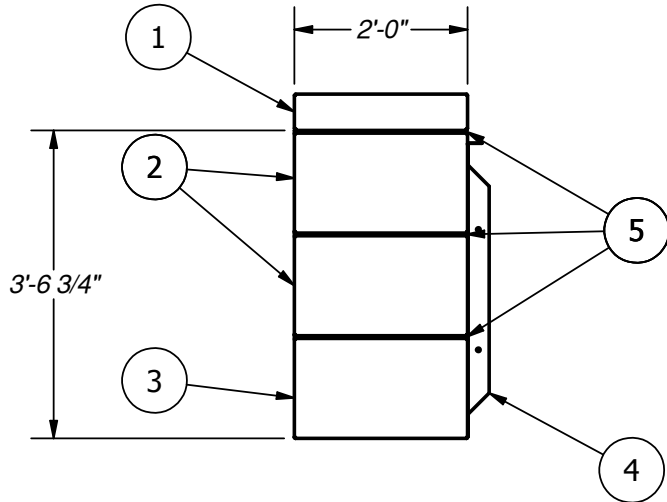

PARTS LIST			
ITEM	PART NUMBER	QTY	DESCRIPTION
1	SR0064	1	2'-0" STEP RISER
2	TD0326	2	2'-0" TREAD
3	BT0201	1	2'-0" BOTTOM TREAD
4	TS0069	1	3'-6" TREAD SUPPORT
5	LT0030	3	2'-0" LINER TRACK

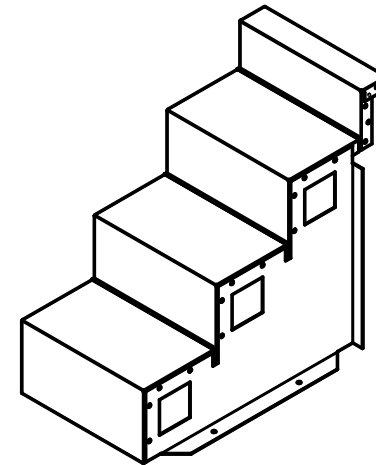

NOTE:
USE REBAR HOLE LOCATIONS TO PIN WALL AND STEP DECK SUPPORTS IN PLACE. THEN POUR 4"-6" OF CONCRETE AROUND THESE AREAS AND UNDER THE ASSEMBLY FOR REINFORCEMENT

Drawn By: nrentschler	Date: 10/30/2018
Scale: SCALE	Notes: ST009665

This information is the confidential property of Cardinal Systems, Inc. Disclosure or duplication without proper written approval is strictly prohibited. Acceptance and use of this drawing constitutes knowledge and acceptance by the user of the terms and conditions set forth in the notice and warning which accompanied this drawing is incorporated herein and made part hereof and is found on Cardinal Systems, Inc's website at www.CardinalSystemsInc.com



CardinalSystemsInc.com



Name: 8'-0" STEEL MODULAR STEP SECTION (1'-2 1/4" TREADS)

Number: 8FTSTMODSECS

250 Route 61 South, Schuylkill Haven, PA 17972 • 570-385-4733 • fax: 570-385-1318 • CustomerService@CardinalSystemsinc.com

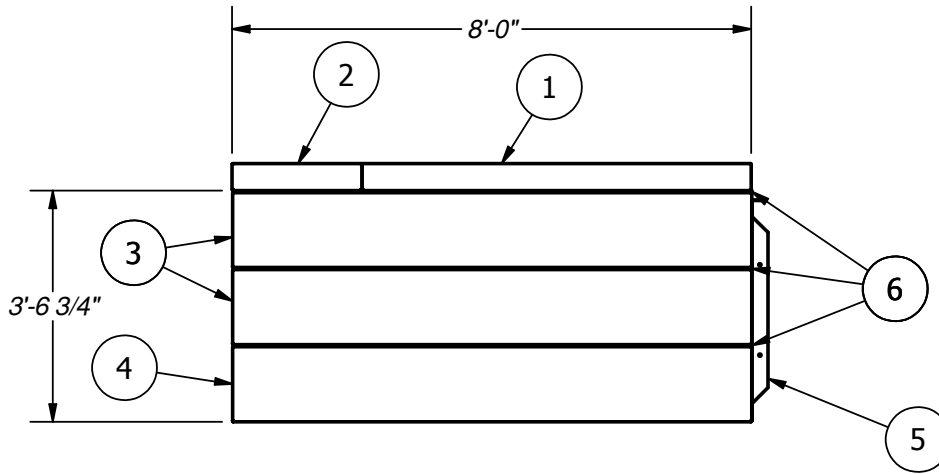

PARTS LIST			
ITEM	PART NUMBER	QTY	DESCRIPTION
1	SR0010	1	6'-0" STEP RISER
2	SP0024	1	2'-0" STEP PANEL
3	TD0847	2	8'-0" TREAD
4	BT0141	1	8'-0" BOTTOM TREAD
5	TS0069	1	3'-6" TREAD SUPPORT
6	LT0024	3	8'-0" LINER TRACK
	BP106ST	1	LARGE STEP BOLT PACK

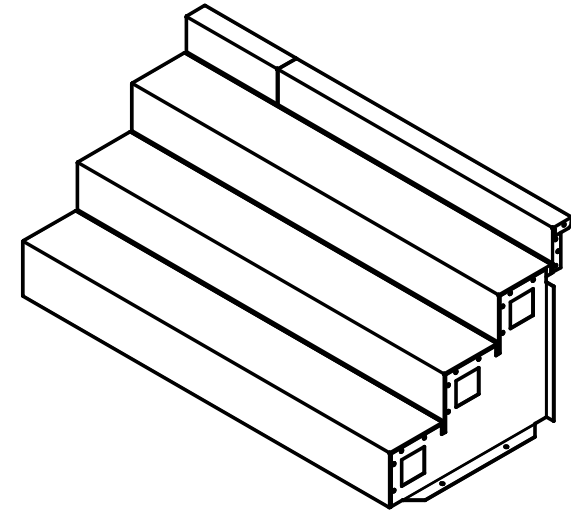
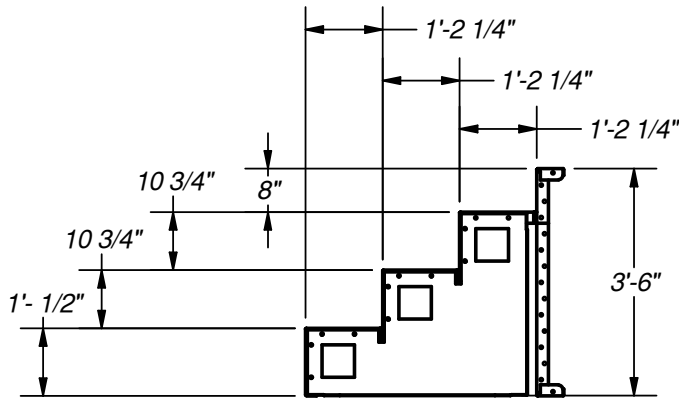

NOTE:
USE REBAR HOLE LOCATIONS TO PIN WALL AND STEP DECK SUPPORTS IN PLACE. THEN POUR 4"-6" OF CONCRETE AROUND THESE AREAS AND UNDER THE ASSEMBLY FOR REINFORCEMENT

Drawn By: nrentschler

Date: 10/30/2018

Scale: SCALE

Notes: ST009667

This information is the confidential property of Cardinal Systems, Inc. Disclosure or duplication without proper written approval is strictly prohibited. Acceptance and use of this drawing constitutes knowledge and acceptance by the user of the terms and conditions set forth in the notice and warning which accompanied this drawing is incorporated herein and made part hereof and is found on Cardinal Systems, Inc's website at www.CardinalSystemsInc.com



CardinalSystemsinc.com