

REPLACES 8'-6" OF STEEL

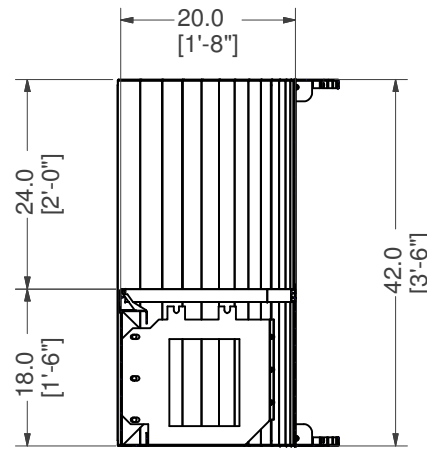

SECTION A-A
SCALE 1/11

OT Bench Radius 7'5" X 5'RA

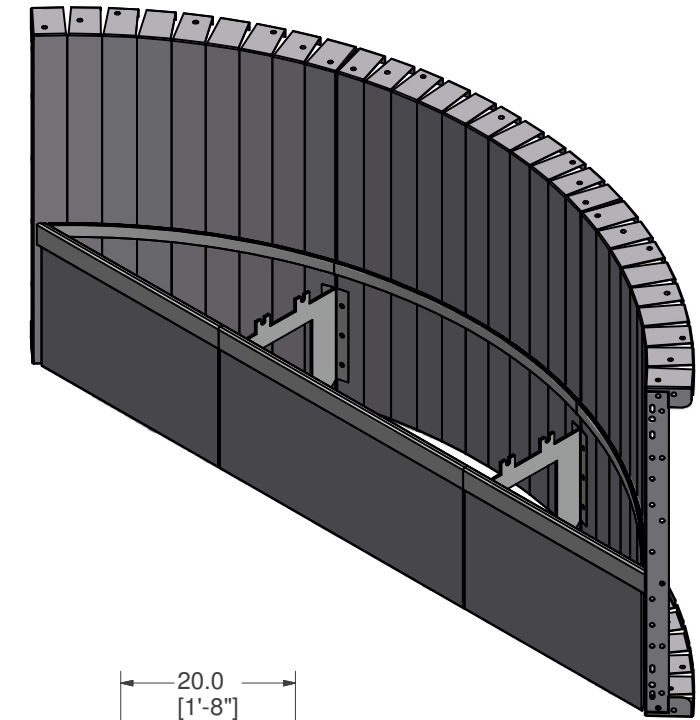
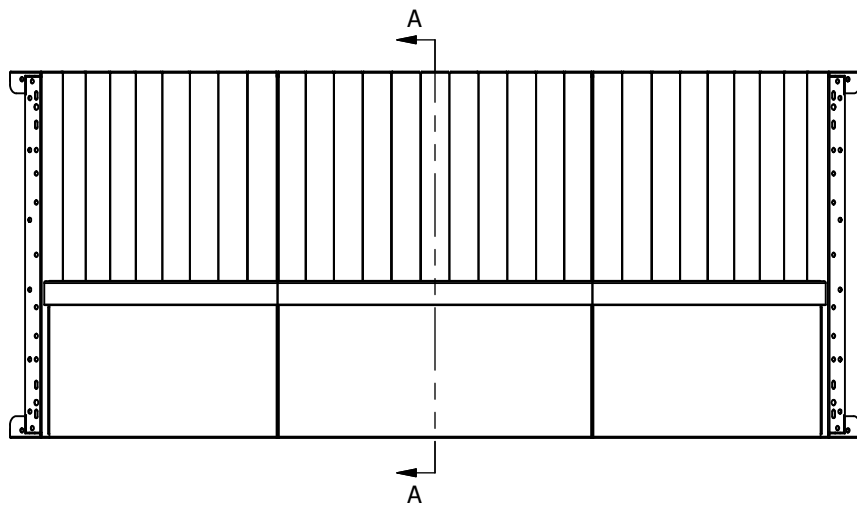

TOLERANCES EXCEPT AS NOTED:

0/0 0.0 0.00 0.000 0°
±1/8 ±0.25 ±0.0625 ±0.03125 ±1/2°

DATE : 1/12/2017

PART #: SOK-BN089R060

SHEET : 1 OF 2

SECTION: 11 - 2