

REPLACES 11'-0" OF STEEL

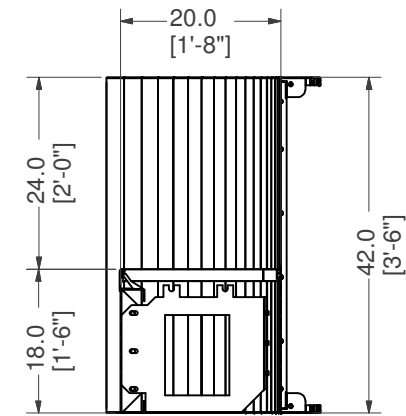

SECTION A-A
SCALE 1/12

OT Bench Radius 9'9" X 8'RA

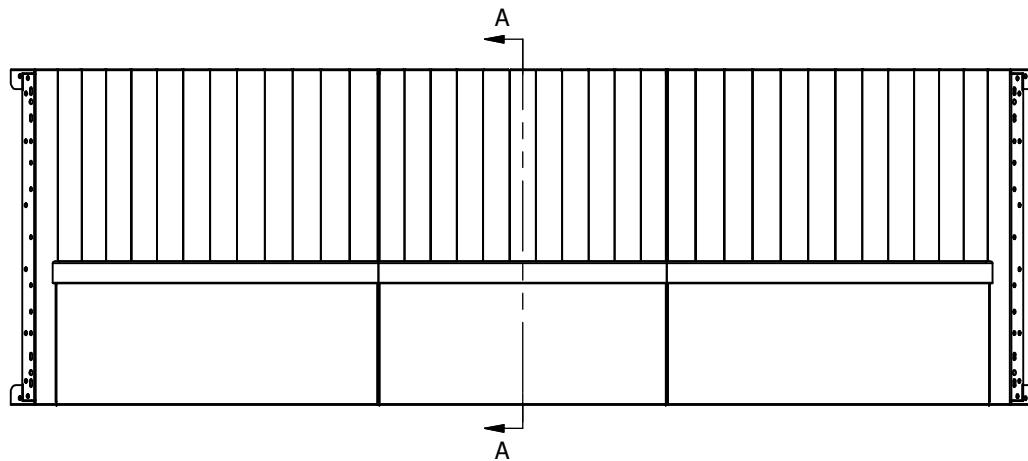

TOLERANCES EXCEPT AS NOTED:

0/0 0.0 0.00 0.000 0°
±1/8 ±0.25 ±0.0625 ±0.03125 ±1/2°

DATE : 1/12/2017

PART #: SOK-BN117R096

SHEET : 1 OF 2

SECTION: 11 - 7