

Parts List		
ITEM	QTY	PART NUMBER
1	24	COP-KCVRET-W-1
2	2	IPC-AB90
3	21'	OPC-CONREC-120
4	23'	SSC-1099
5	1	SSC-2309
6	1	SSC-2310
7	1	SSC-2315
8	1	SSC-2316
9	1	SSC-2317
10	1	SSC-2318
11	2	SSC-2616
12	2	SSC-2617
13	2	SSC-2618
14	2	SSC-2619

NOTE: PVC 6 " RADIUS INSERTS WILL BE PROVIDED WITH ALL STEP/BENCH KITS THAT HAVE 90 DEGREE CORNER.

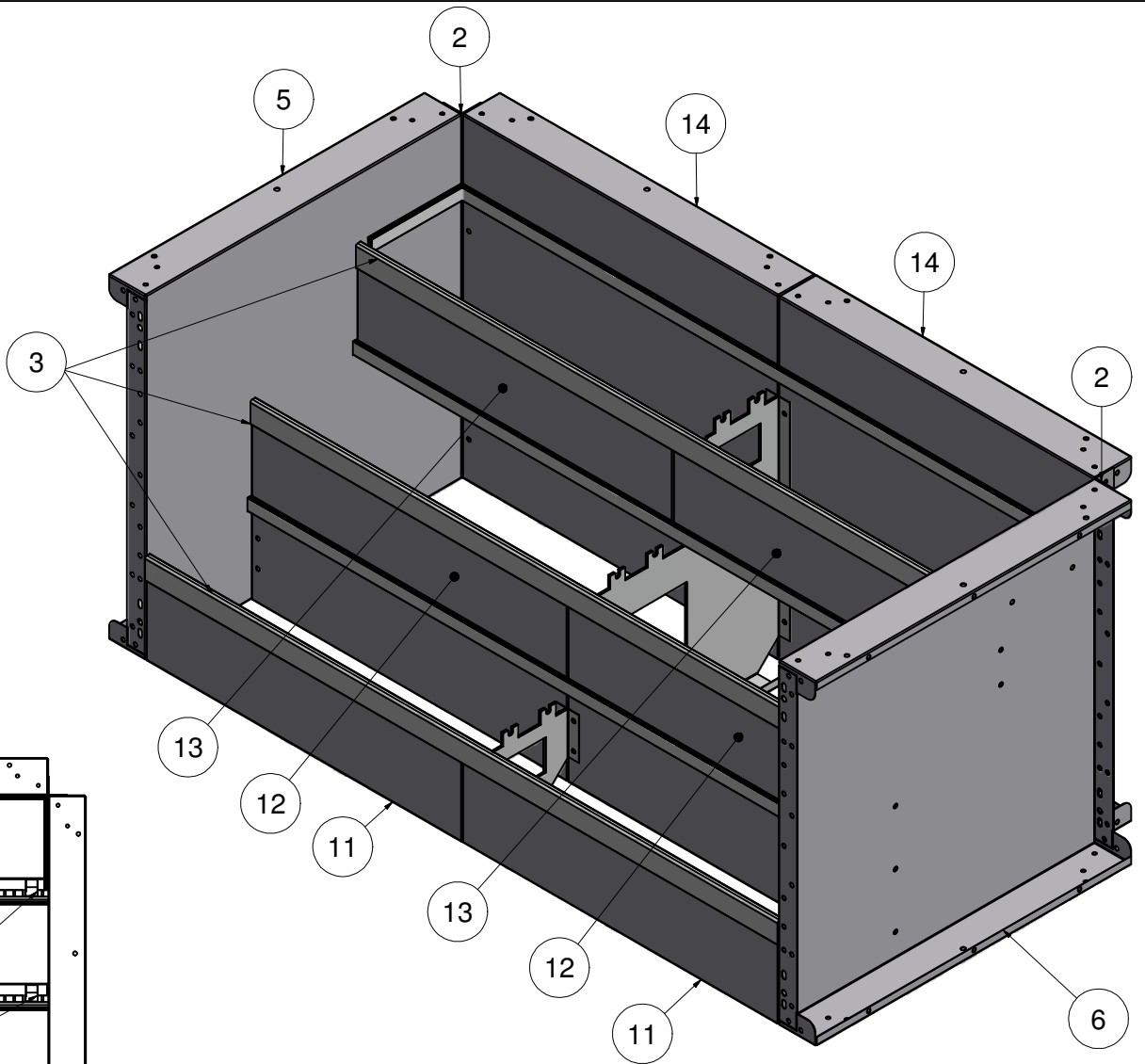

OT STEP STR-90D 3 TRD 7'

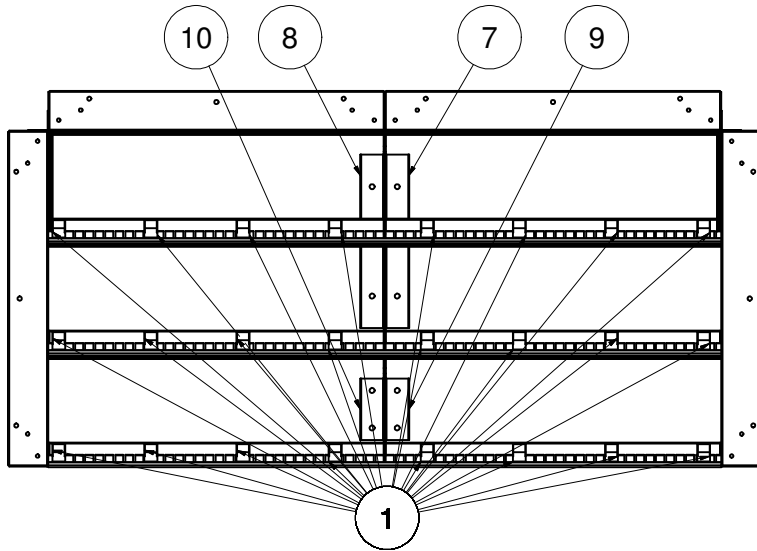

TOLERANCES EXCEPT AS NOTED:

0/0 0.0 0.00 0.000 0°
 ±1/8 ±0.25 ±0.0625 ±0.03125 ±1/2°

DATE : 1/12/2017

PART #: SOK-ST084ST90

SHEET : 2 OF 2

SECTION: 1 - 5