

Parts List		
ITEM	QTY	PART NUMBER
1	30	COP-KCVRET-W-1
2	2	IPC-AB90
3	24'	OPC-CONREC-120
4	26'	SSC-1099
5	1	SSC-2309
6	1	SSC-2310
7	2	SSC-2311
8	2	SSC-2312
9	2	SSC-2313
10	2	SSC-2314
11	1	SSC-2315
12	1	SSC-2316
13	1	SSC-2317
14	1	SSC-2318

**NOTE: PVC 6 " RADIUS INSERTS WILL BE PROVIDED WITH ALL STEP/BENCH KITS THAT HAVE 90 DEGREE CORNER.**

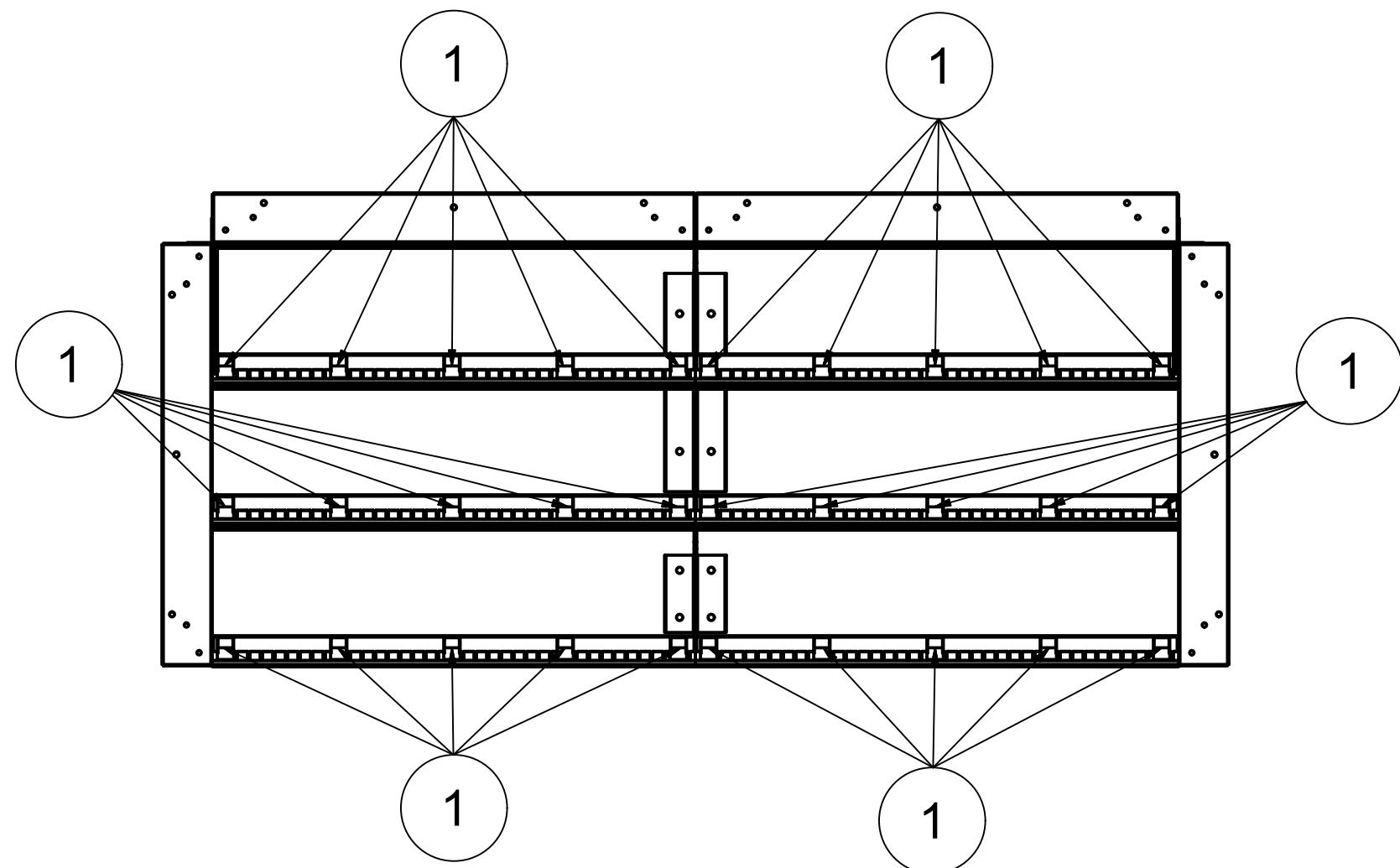

## OT STEP STR-90D 3 TRD 8'

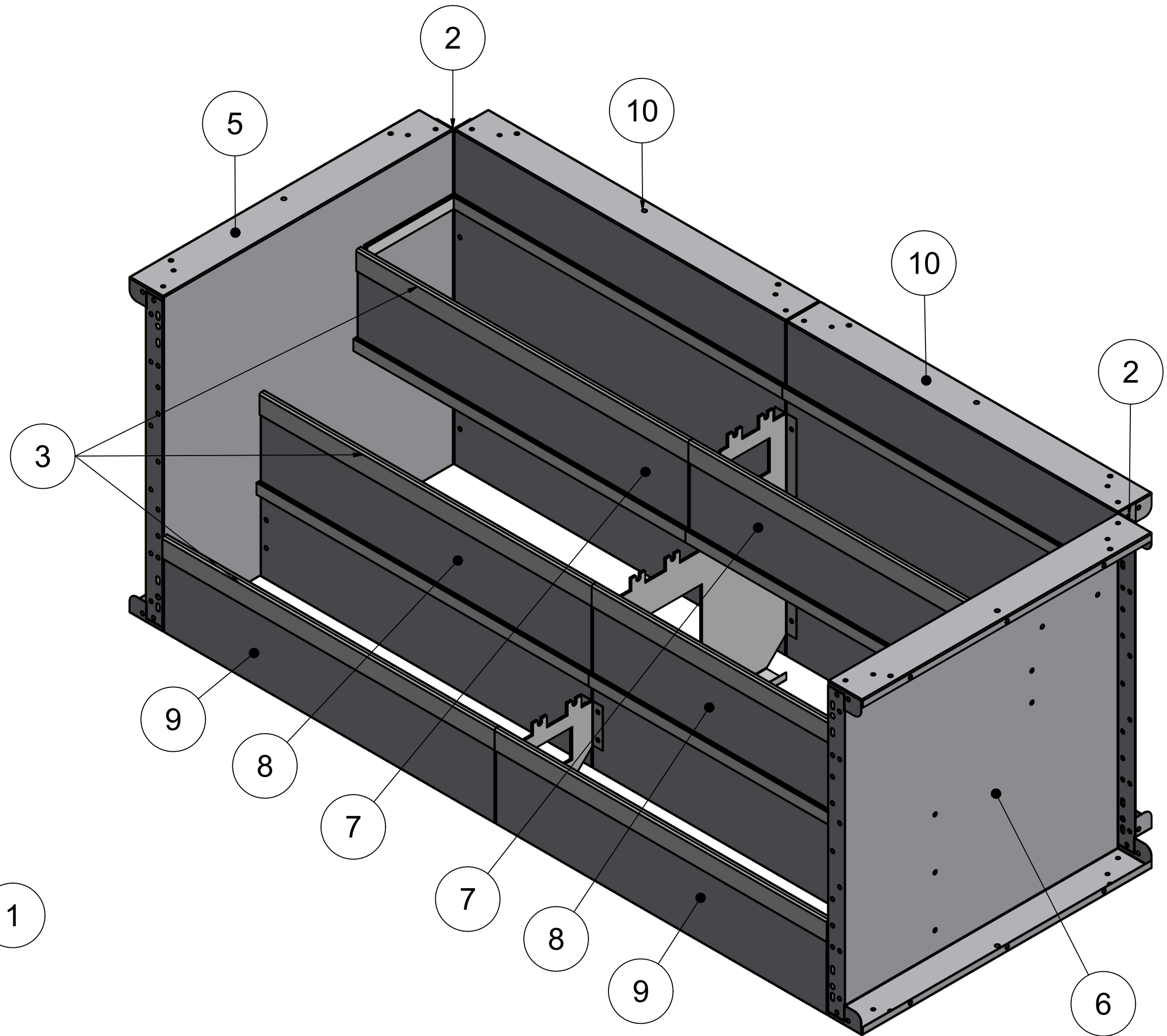

TOLERANCES EXCEPT AS NOTED:

0/0 0.0 0.00 0.000 0°  
±1/8 ±0.25 ±0.0625 ±0.03125 ±1/2°

**DATE : 1/6/2017**

**PART #: SOK-ST096ST90**

**SHEET : 2 OF 2**

**SECTION: 1 - 6**