

Parts List		
ITEM	QTY	PART NUMBER
1	32	COP-KCVRET-W-1
2	2	IPC-AB90
3	32'	OPC-CONREC-120
4	34'	SSC-1099
5	1	SSC-2490
6	1	SSC-2491
7	2	SSC-2497
8	2	SSC-2498
9	2	SSC-2499
10	2	SSC-2500
11	2	SSC-2501
12	1	SSC-2507
13	1	SSC-2508
14	1	SSC-2509
15	1	SSC-2510
16	1	SSC-2511
17	1	SSC-2512

NOTE: PVC 6" RADIUS INSERTS WILL BE PROVIDED WITH ALL STEP/BENCH KITS THAT HAVE 90 DEGREE CORNER.

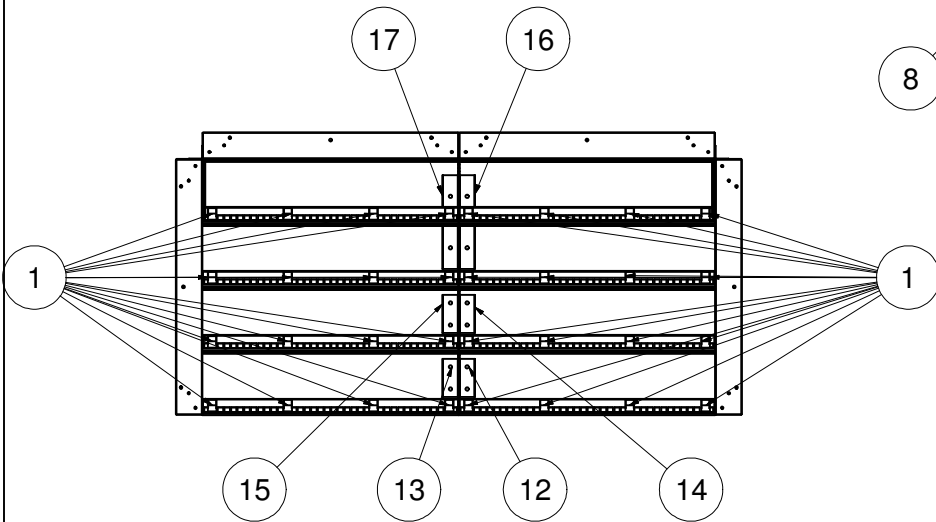

OT STEP STR-90D 4 TRD 8'

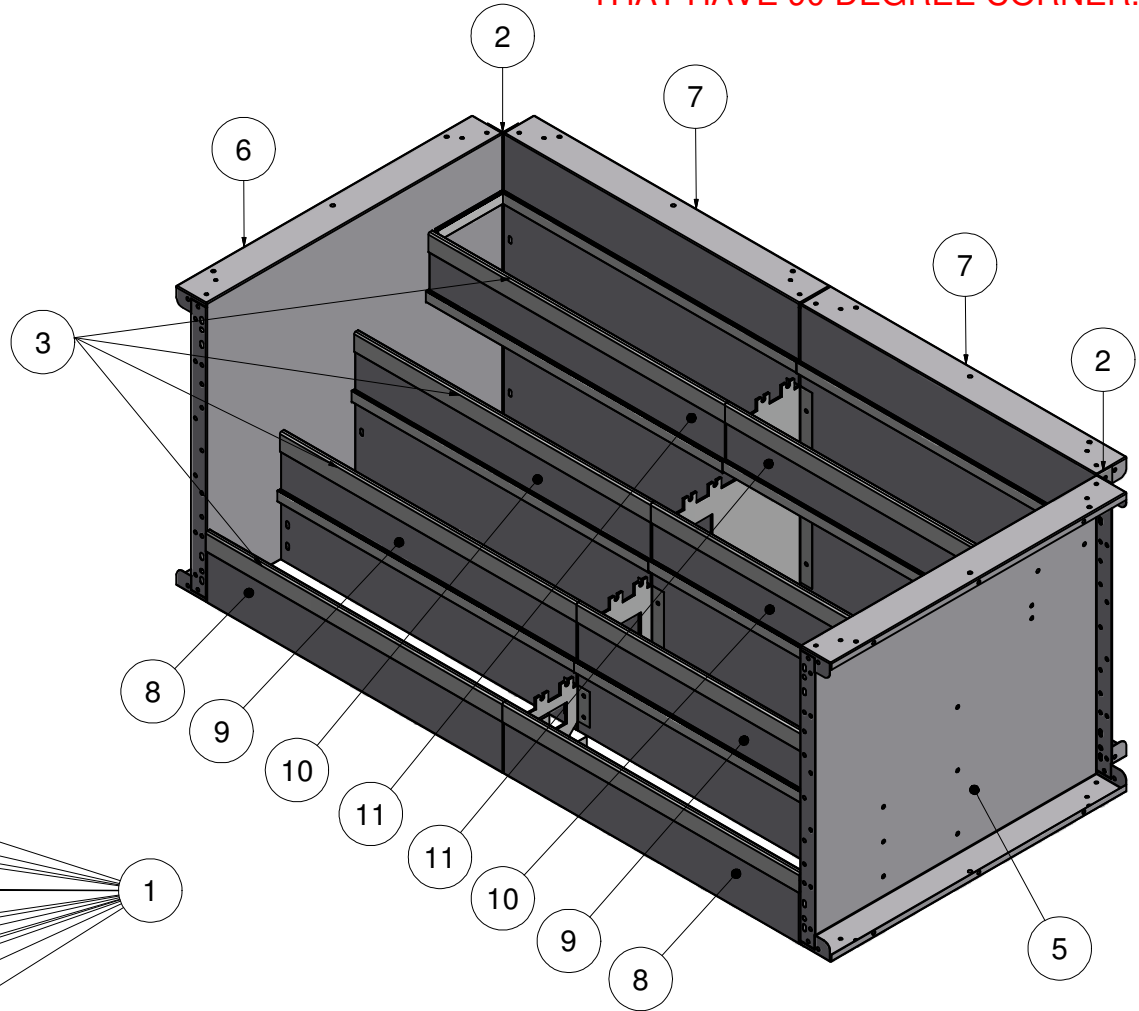

TOLERANCES EXCEPT AS NOTED:

0/0 0.0 0.00 0.000 0°

±1/8 ±0.25 ±0.0625 ±0.03125 ±1/2°

DATE : 1/12/2017

PART #: SOK-ST096ST904T

SHEET : 2 OF 2

SECTION: 2 - 5