

# Straight and Corner Wedding Cake Steps

## Installation Instructions

Thanks for buying our step. Identify the parts: See the following two pages of illustrations.

### Straight wall step : Kit Contents

1 Step form

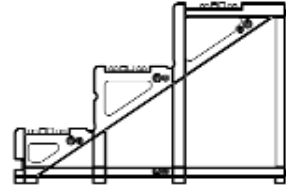
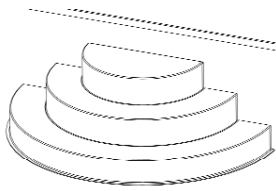

7 Braces  
PH396001

### Contained in Carton:

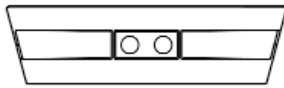

6 Tread-3 supports  
PH396004

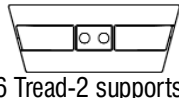

6 Tread-2 supports  
PH396005



6 Toe Braces PH396010



1 Warning Decal

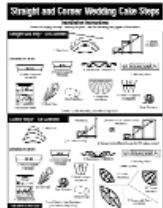

1 Instruction Sheet



20 Rod Clips



Rod End Caps

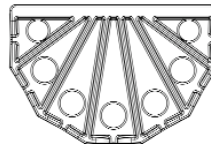

2 Straight Hub  
PH396006



6 Tread-1 supports  
PH396029



Base Extrusion

3 Rods – Liner Retainers, attached to step form

### Corner steps: Kit Contents

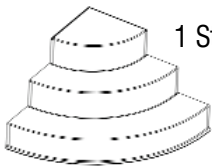

1 Step form



(2 ft. radius brace)

(Square or 6 in. radius brace)  
PH396001

**OR**

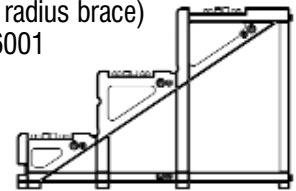

4 Braces (note different brace for 2ft radius corner)

### Contained in Carton:

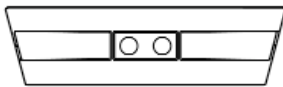

3 Tread-3 supports  
PH396004

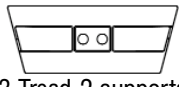

3 Tread-2 supports  
PH396005



3 Toes Braces PH396010



1 Warning Decal

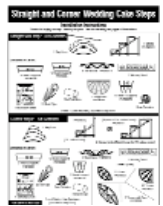

1 instruction sheet



20 Rod Clips



Base Extrusion



3 Tread-1 support  
PH396029

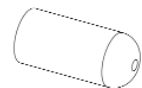

Rod End Caps

3 or 4 Rods - Liner Retainers  
(attached to step form)

### 2 HUBS (VARI)

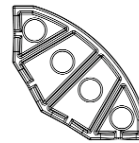

6" Corner  
PH396008

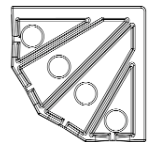

90° Corner  
PH396007

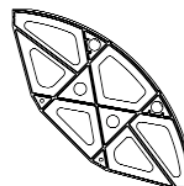

2' Corner with Pipes  
PH396009

- Parts shown are not to scale

**Additional materials needed:**

- Tape
- Screws to attach braces to walls
- Duct tape

**Prepare the site:**

The design of this step assembly requires that it be installed on a level concrete floor of a pool. The pool walls must be plumb and either straight (for the straight wall version) or square (for the corner version). The base corner between floor and wall should be square, without any cove. The step is designed to be installed against a solid wall that is 43" high from the pool bottom to the deck finished surface. Changes from this 43" height will cause the first step rise to the deck to become higher or lower than the desired 11" rise. Please conform to applicable building codes when installing this step.

If there are variations in the floor level, a leveling grout or mortar should be used to correct these prior to step installation. It may be preferable to grind one or more interior brace legs, and/or the bottom center hub to better conform to small irregularities of the floor. DO NOT grind any of the outer perimeter legs, as shortening these legs will cause the step form to touch the floor in this area and not rest on the brace. Shimming under the braces is acceptable provided the shims are at least 4" square and are bonded to the floor so that they don't shift. It is important to ensure that all brace legs are supported by and in contact with the floor, before installing the step form. Failure to properly support the brace assembly may result in warping or collapse of the step.

**Installing brace and tread structure:**

Once the site has been prepared, the braces and treads may be installed.

For straight wall installations, determine where the center of the step should be. Mark a vertical line on the wall at this center point. Place a hub centered on this line, with the notches facing up. Set the braces into this hub, and insert the second hub at the top of the braces. Install the toe braces around the outer edge of the braces. This assembly should now be quite solid. Check to be sure that the assembly is centered about the vertical line, and attach the two rear braces to the wall with appropriate fasteners through the holes provided. Note that the braces will stand off the wall about 1/4". This is correct, and will allow the step form to be retained behind the edge of the braces.

For corner installations, place a hub in the corner, with the notches facing up. Set the braces into this hub, and insert the second hub at the top of the braces\*. Install the toe braces around the outer edge of the braces. The assembly should now be quite solid. Check to be sure that the assembly fits snug into the corner, and attach the two rear braces to the walls with appropriate fasteners through the holes provided. Note that the braces will stand off the wall about 1/4". This is correct, and will allow the step form to be retained behind the edge of the braces.

*\*(2ft. radius corners will use two pipes between hubs.)*

- Once this assembly is secured to the wall(s), snap the tread supports into place.
- Attach the flexible base extrusion to the step form. Use small strips of duct tape to keep extrusion in place while setting form.
- Place step form over brace structure, sliding back edge of step form behind braces at the wall(s). Be sure that step form is fully seated against wall(s) and braces. Insert a round screwdriver blade into the clip hole at the tread/riser intersection to act as a handle to lift the upper portion of the form onto the brace system (use the opposite hand to lift the bottom). Check that the step form is touching the floor in all areas.
- Tape the joint between step form and wall as needed.
- Install liner, using rods, rod end caps and clips.
- Apply "Warning Label" to top of liner wall, above step.

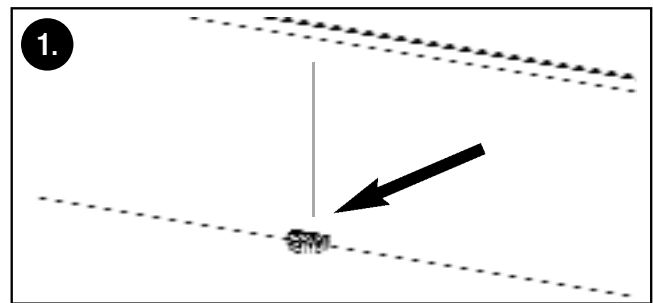

1. Set hub at center of step location.

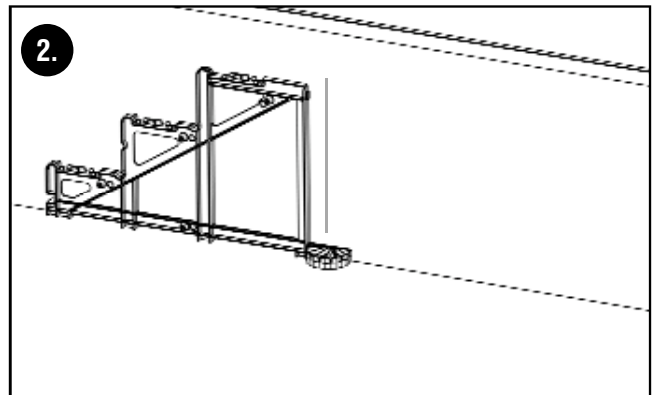

2. Set tab of brace into hub notch.

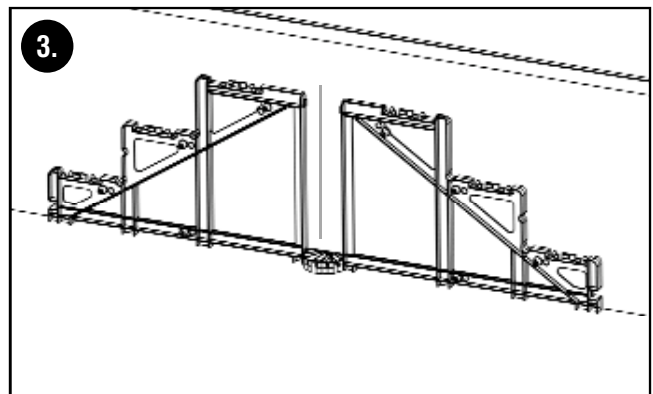

3. Install second brace to other side of hub

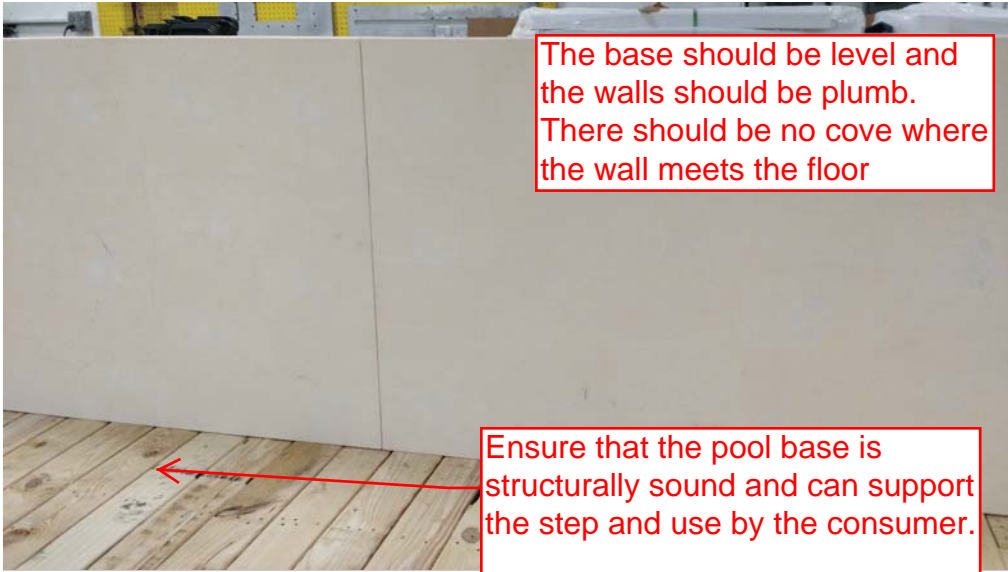

The base should be level and the walls should be plumb. There should be no cove where the wall meets the floor

Ensure that the pool base is structurally sound and can support the step and use by the consumer.



Center the hub on the location selected for the step



Start placing the braces at the wall. The tab on the brace fits into the slot on the hub.







Complete adding all 7 braces to the hub



The second hub will lock the braces together



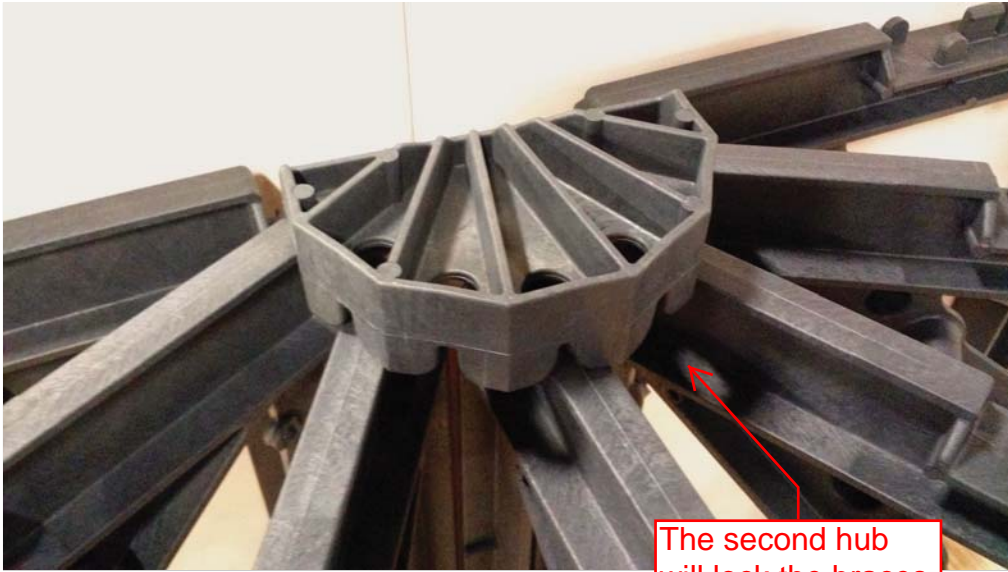

The second hub will lock the braces together

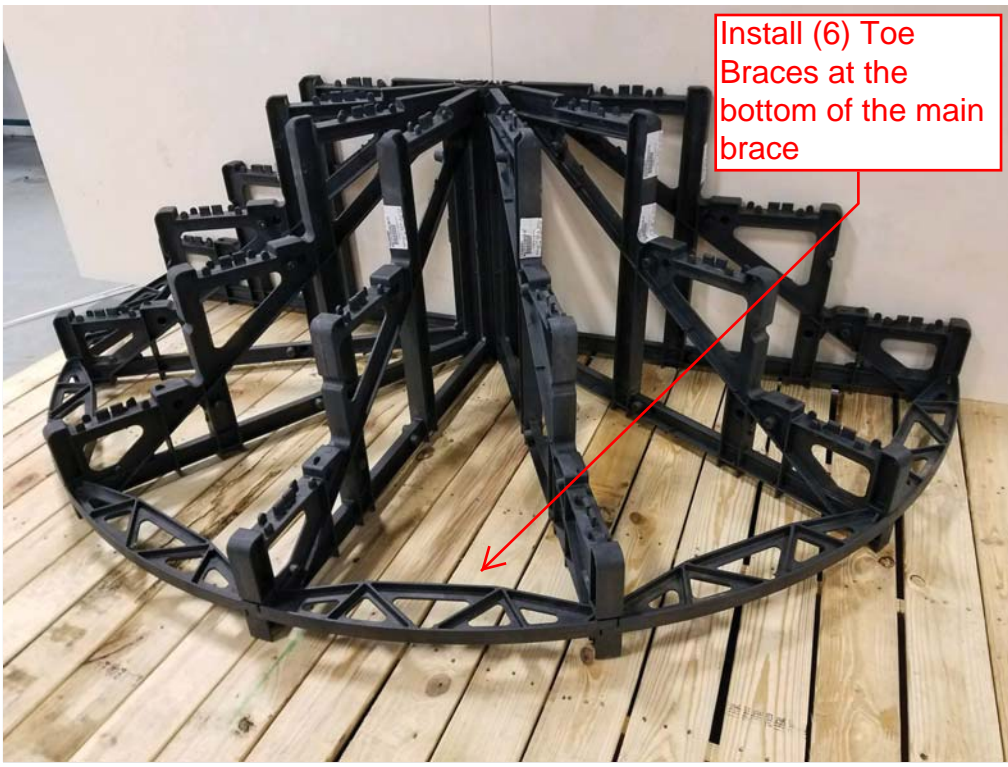

Install (6) Toe Braces at the bottom of the main brace

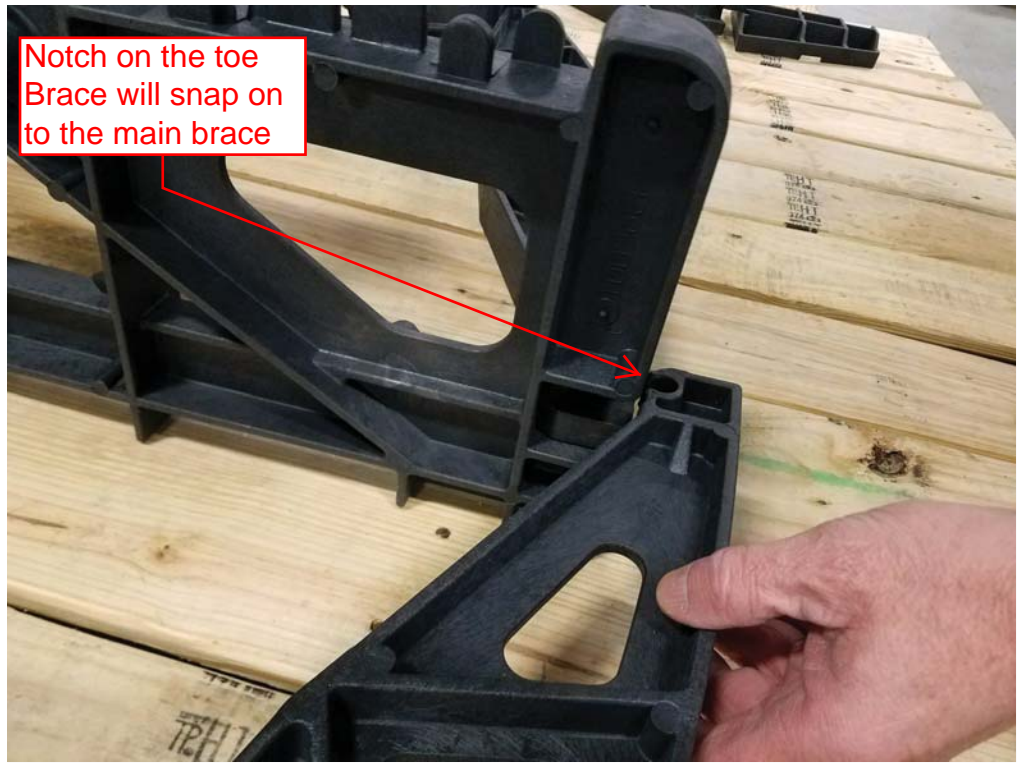

Notch on the toe Brace will snap on to the main brace



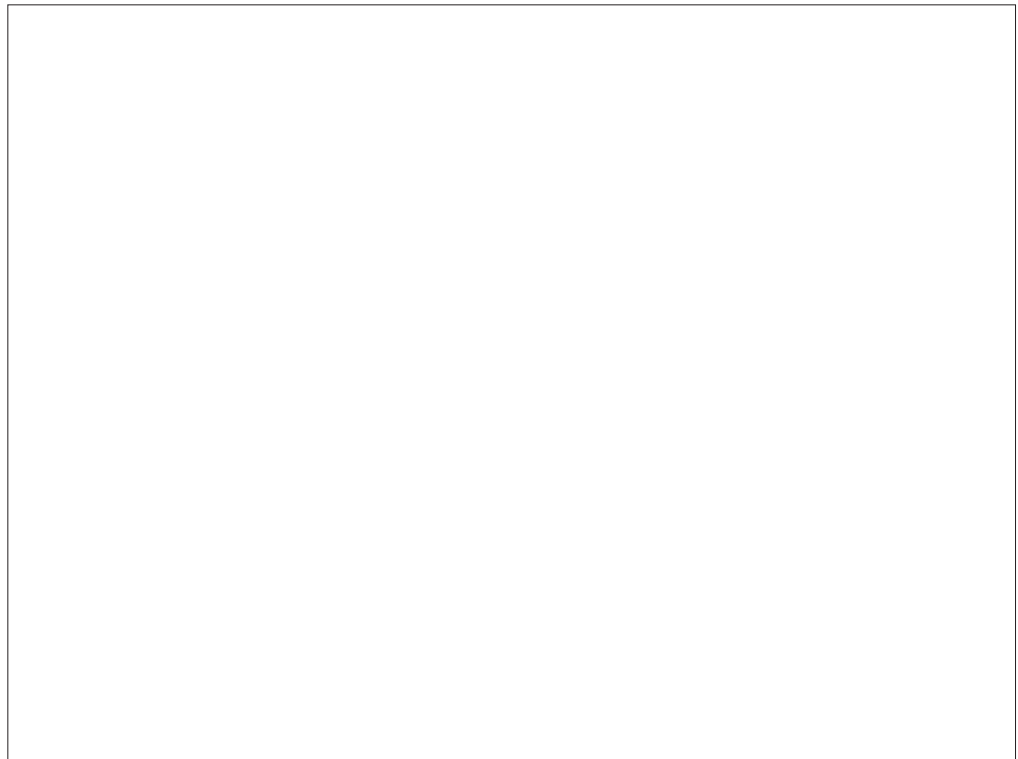
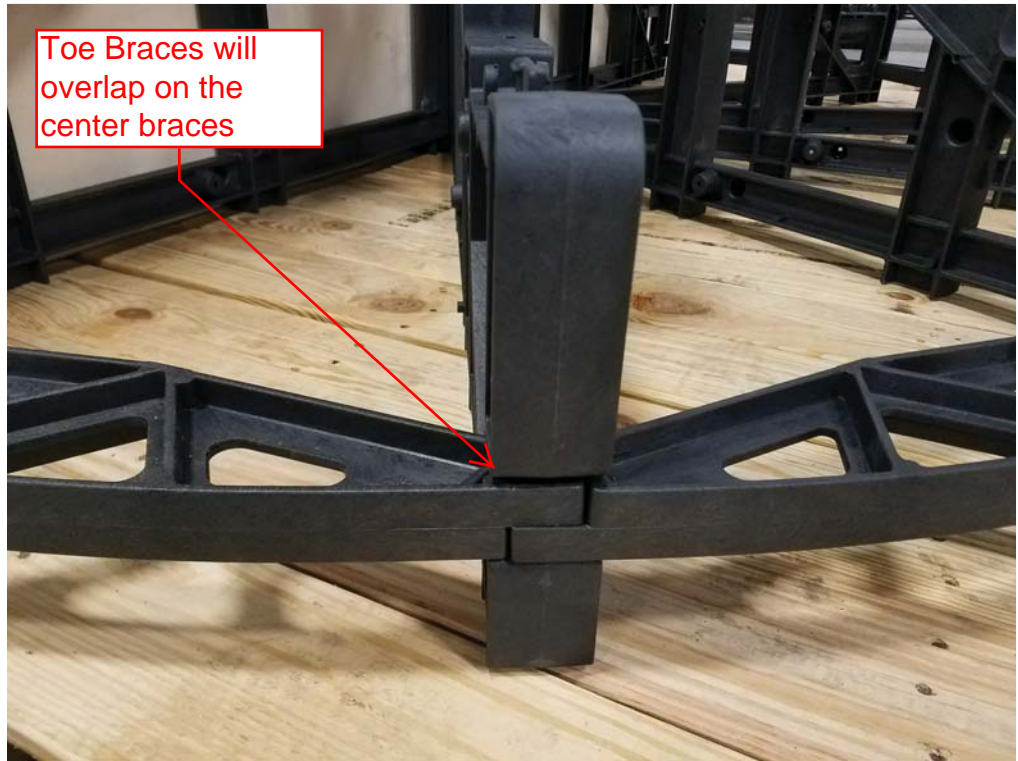





Install (6) Tread Three supports on the main braces as shown

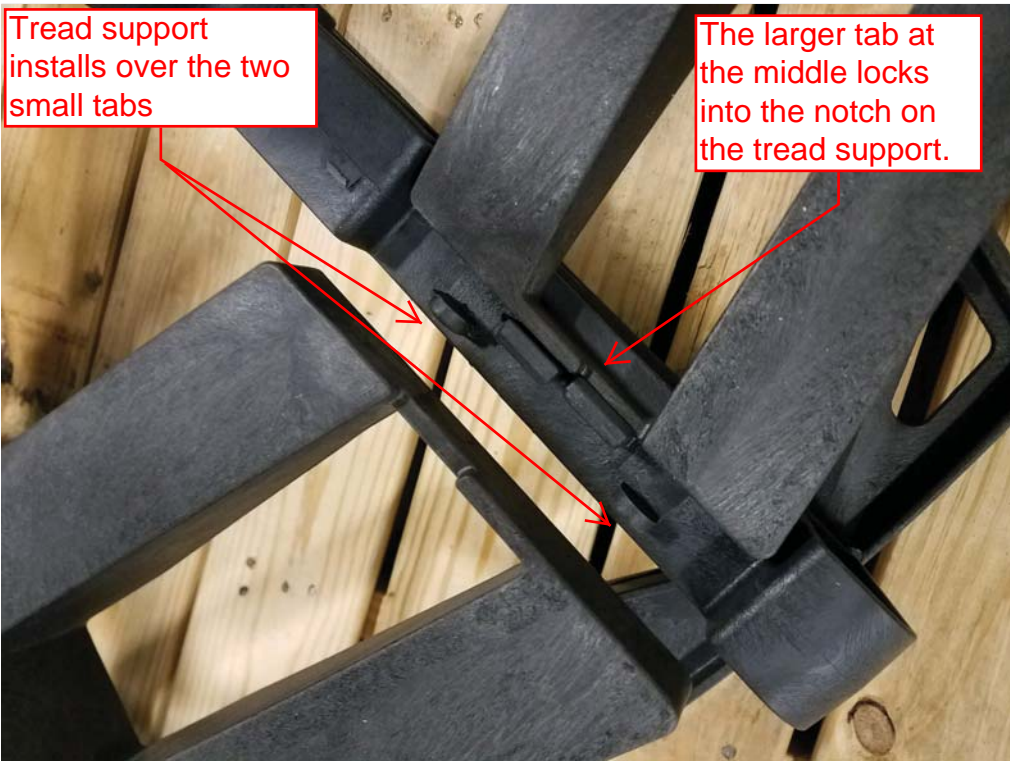

Tread support installs over the two small tabs

The larger tab at the middle locks into the notch on the tread support.





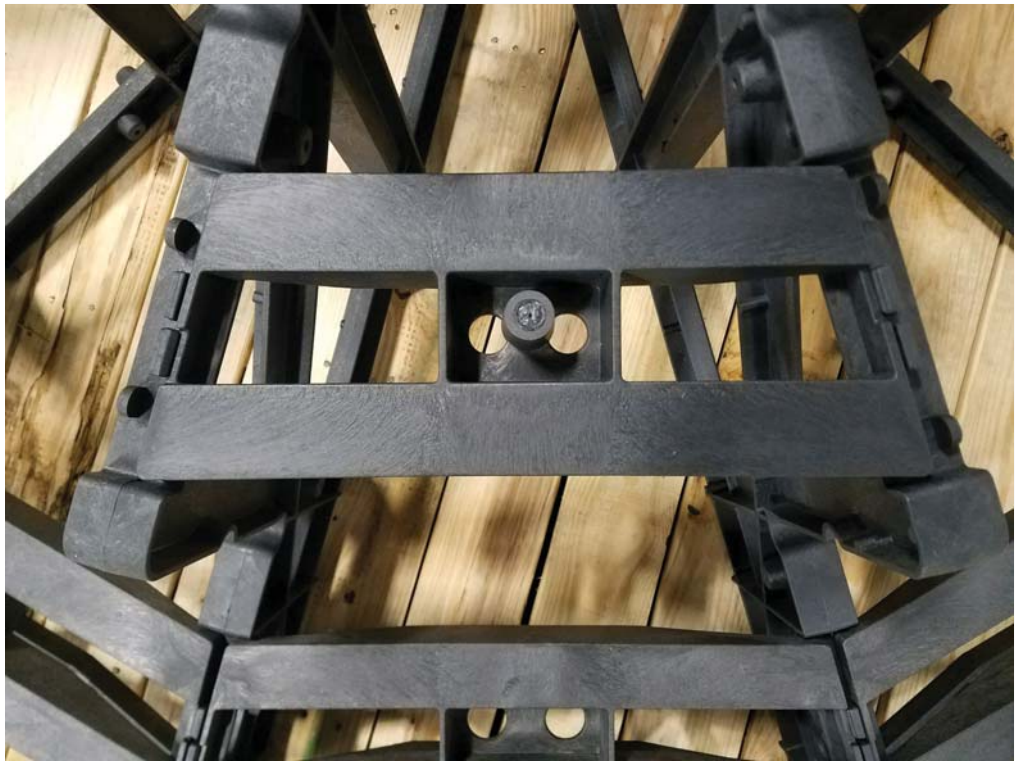
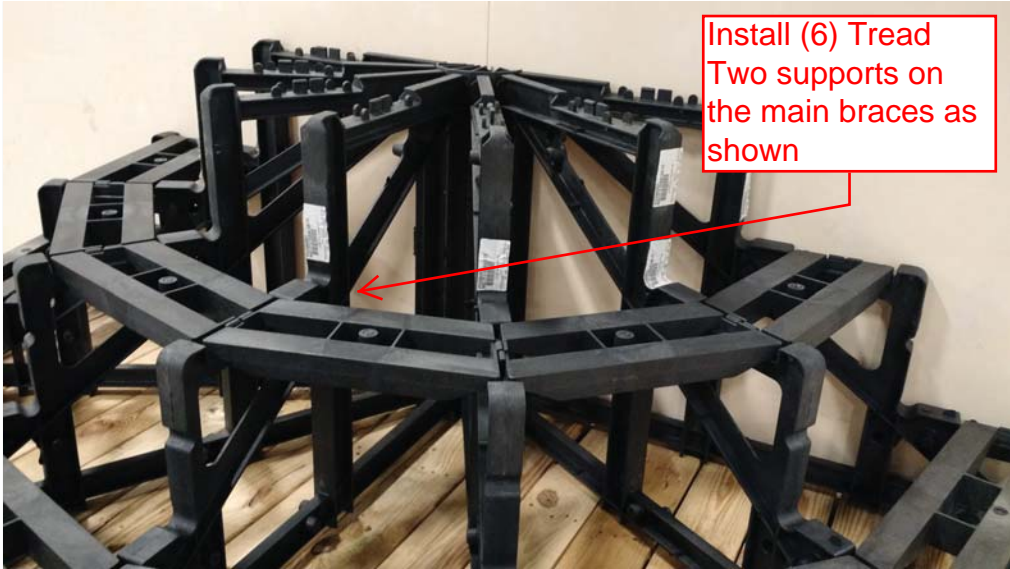



Install (6) Tread  
One supports on  
the main braces as  
shown



This is the completed  
bracing structure.

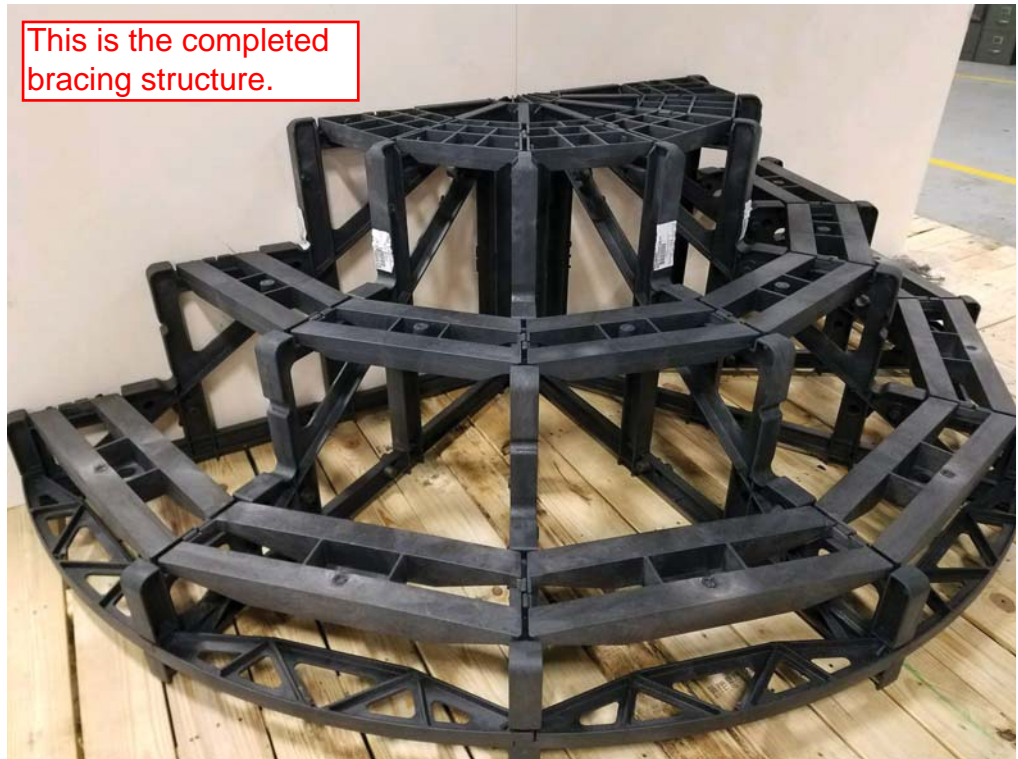



Optional: Braces can be screwed to the pool wall to prevent them from moving off the desired location. These are not structural to the step.

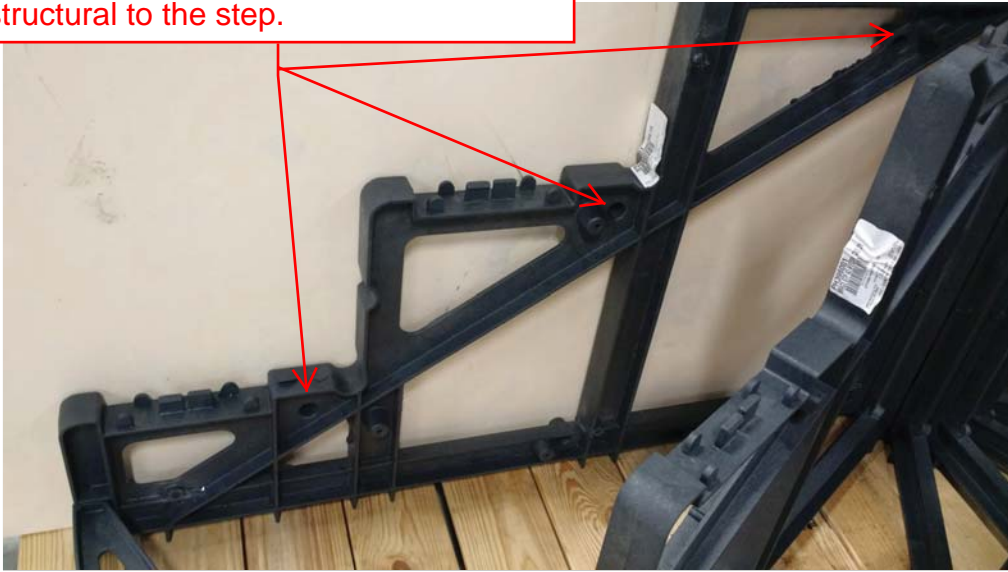

Install base extrusion on the bottom of the step shell. Use tape to secure the extrusion to the shell

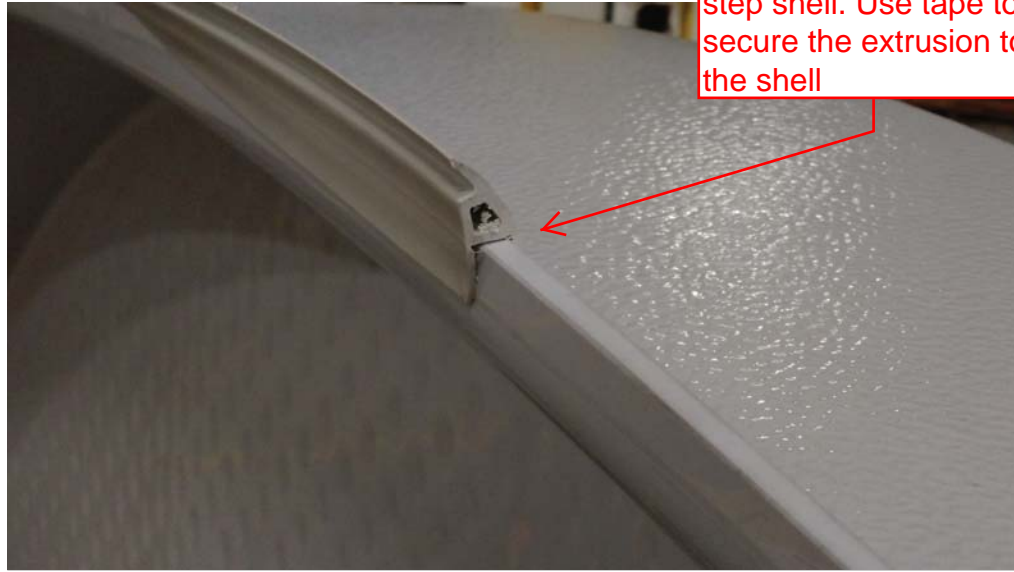

Rod clip holes

