



AquaRite®

# Troubleshooting Guide Residential



TSG-AQR159d

Copyright 2017 Hayward Industries Inc.

# Safety Precautions



## High Voltage Electrocution Hazard

Hazardous voltage can shock, burn, cause serious injury and or death. To reduce the risk of electrocution and or electric shock hazards:

- Only qualified technicians should remove the panel
- Replace damaged wiring immediately
- Insure panel is properly grounded and bonded

# Table of Contents

How AquaRite® Works, Main PCB Layout, Chemistry Requirements

Pg. 4-6

## How To:

**Pg. 7-15**

Change Metric to Standard & Change Default Reading

8-9

Set TurboCell® Type & Reset Average Salt

10-11

Adjust Chlorine Output & Clean TurboCell

12-15

## Troubleshooting:

**Pg. 16-38**

1. Check Salt & Inspect Cell: flashing or ON

17-20

2. High Salt: LED ON

21-25

3. No Flow: LED flashing or ON

26-30

4. Display ONLY, Lights ONLY, or Neither

31-36

5. LCD: Displaying “HOT” or “COLD”

37-38

## Additional Information:

**Pg. 39-44**

Cell Compatibility Chart & Salt Addition Table

40-41

Chlorine Output & Salt Levels

42-43

Reading Serial Numbers

44

# AquaRite: How It Works

- The AquaRite Salt Chlorine Generator is designed to convert 99% pure salt into chlorine gas (HOCl).
- The conversion occurs in the Electrolytic Cell, also known as the TurboCell® (used throughout this guide).
- Power is sent from the AquaRite Control Center to the TurboCell, when chlorine production is scheduled (based on time percentage).
- When power is applied to the TurboCell, conductive plates produce a field; which in-turn establishes an electrochemical reaction between Chloride ions & the water to create Hypochlorous Acid.

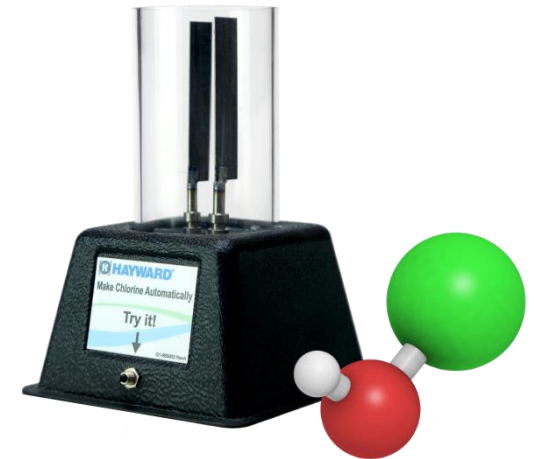



# AquaRite: Main PCB Layout

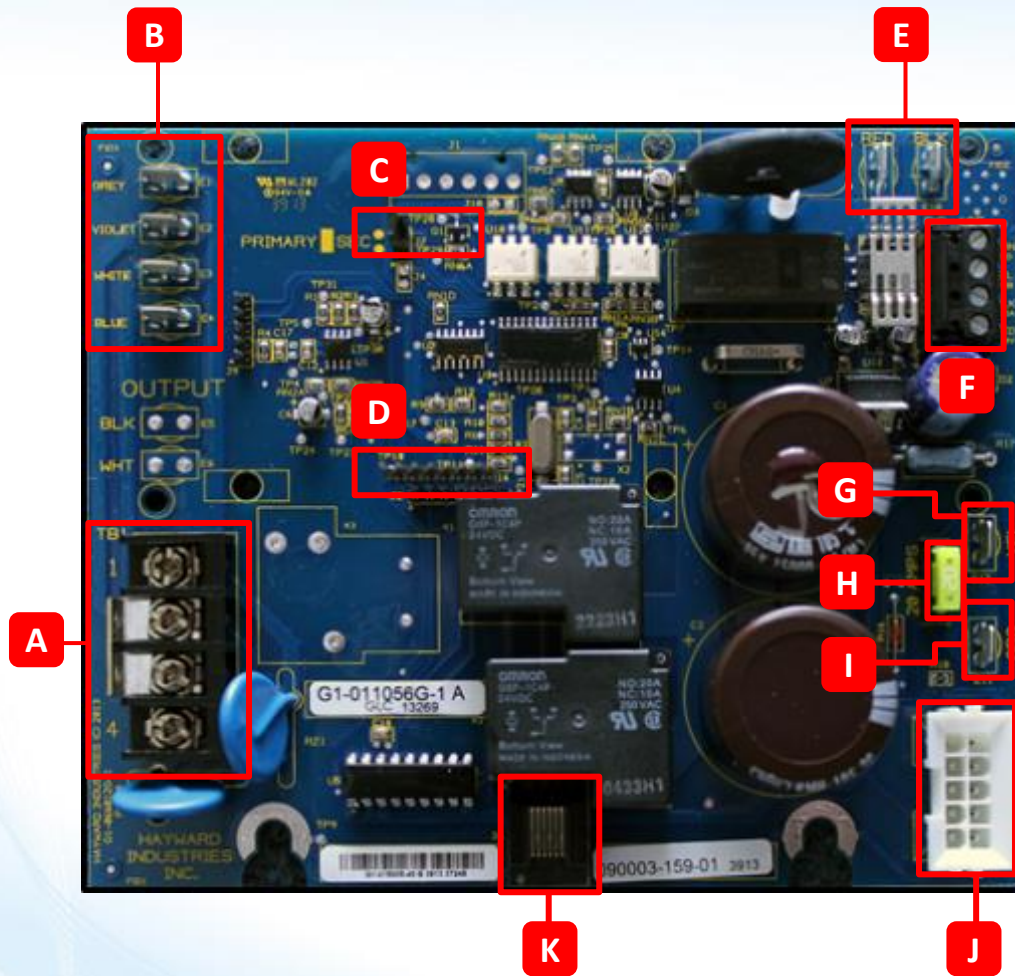

<b>A</b>	PCB Input Power (120/240VAC)
<b>B</b>	Transformer Input (120VAC & 120VAC)
<b>C</b>	External Control Jumper
<b>D</b>	Display Output (5-10VDC)
<b>E</b>	Rectifier Output (18-33VDC)
<b>F</b>	Comm Block – External Control (5-10VDC)
<b>G</b>	Transformer Output (12 VAC)
<b>H</b>	Chlorinator Fuse (20A – ATO style)
<b>I</b>	Rectifier Input (12 VAC)
<b>J</b>	Cell Input/Output
<b>K</b>	Flow Switch Input/Output

# AquaRite: Chemistry Requirements

Test	Ideal Range	Frequency
Free Chlorine	1.0 - 3.0 ppm	Weekly
pH	7.2 - 7.8	
Alkalinity	80 - 120 ppm	Monthly
Salt	2700 - 3400 ppm	
Stabilizer	30 - 50 ppm	Quarterly
Calcium	200 - 400 ppm	



AquaRite®

How To:





# How To: Switch from Metric to US Standard

*If the first reading (average salt) is displayed in decimal form instead of a number represented in thousands, then the unit has been set to 'Metric Mode'.*

Step 1

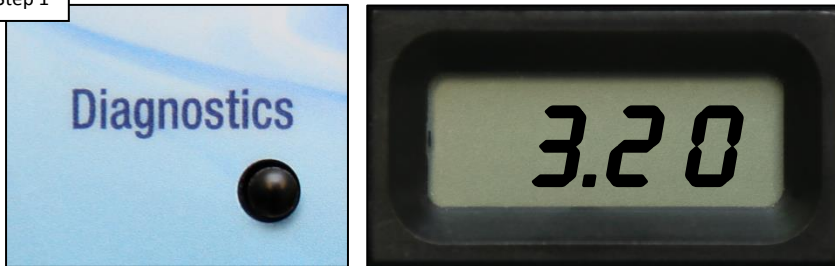

To change the unit from Metric Mode to US Standard, start by pressing the 'Diagnostics' button one time.

Step 2

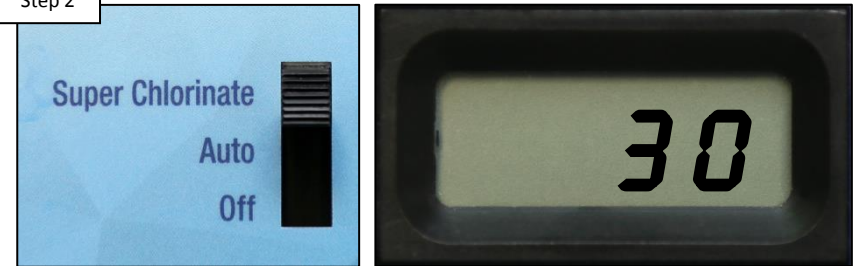

Once showing the temperature in Celsius, move the switch up to 'Super Chlorinate' then back to 'Auto'.

Step 3

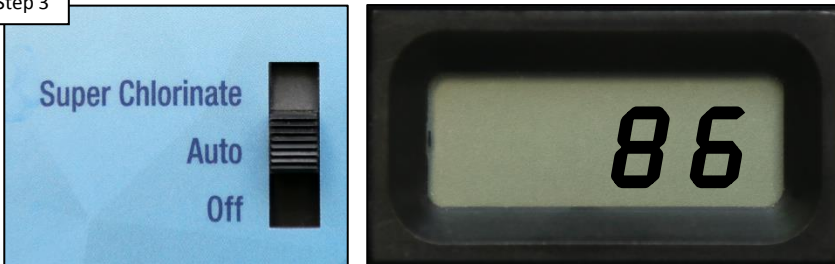

Immediately the temperature reading should change to reflect a Fahrenheit value. If it does not repeat step 2.

Step 4

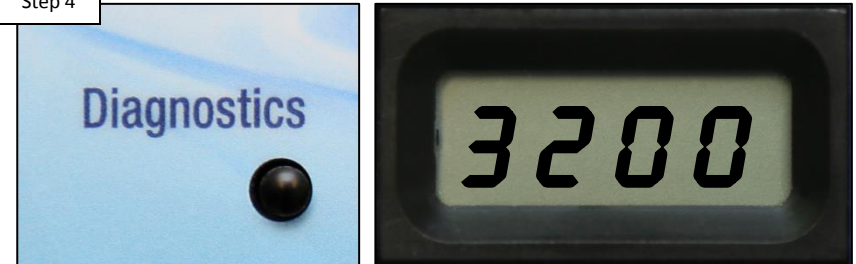

After 30 seconds the unit should settle back to the default reading. The reading should now reflect a number in thousands.

**NOTE: The process is the same to go from US Standard to Metric.**



# How To: Change the Default Display

*If the first reading represents a number followed by the letter 'P', then the default reading has been changed to express the 'Desired Output %'.*

Step 1

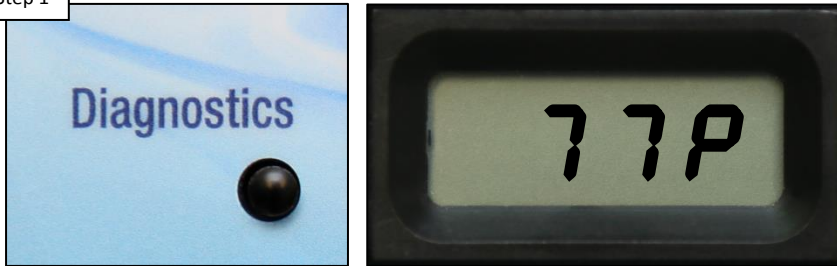

To change the default reading back to the average salt, start by pressing the 'Diagnostics' button two times.

Step 2

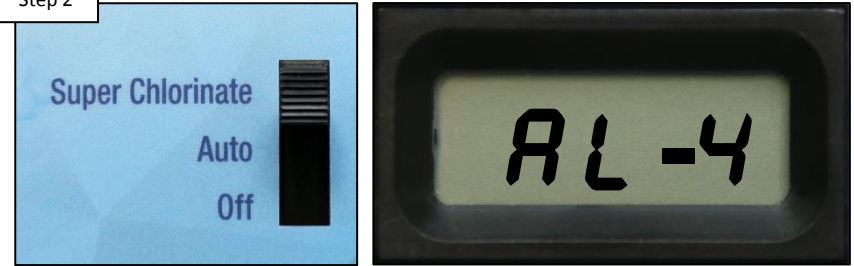

When the unit reads 'AL-4' move the switch up to 'Super Chlorinate' and back to 'Auto'.

Step 3

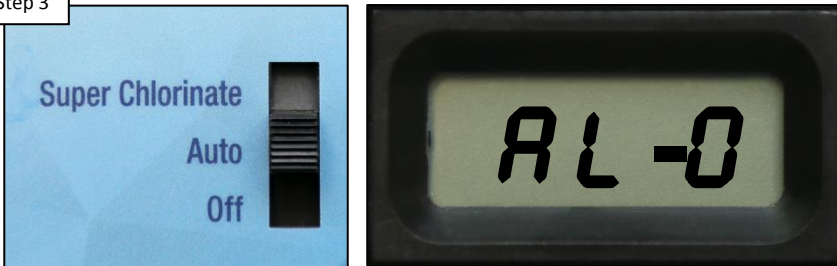

Continue moving the switch up to 'Super Chlorinate' and back to 'Auto' until the display reads 'AL-0'.

Step 4

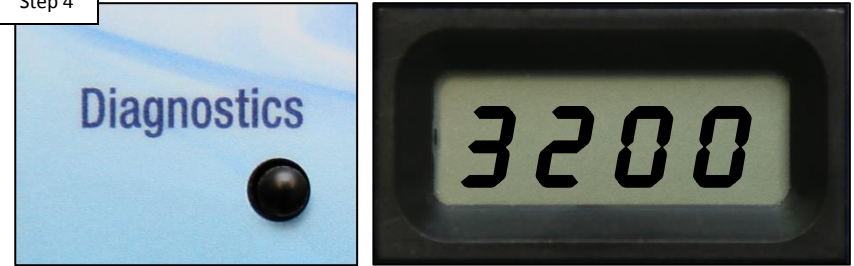

It takes about 30 seconds for the unit to settle back on the default reading. It should now reflect the average salt level.

# How To: Set TurboCell Type

*Before operation, the AquaRite must be configured to the correct TurboCell installed. "t-15" is the factory default. If the incorrect cell is chosen the salt level will be inaccurate and the system will likely suspend chlorination as a result.*

Step 1

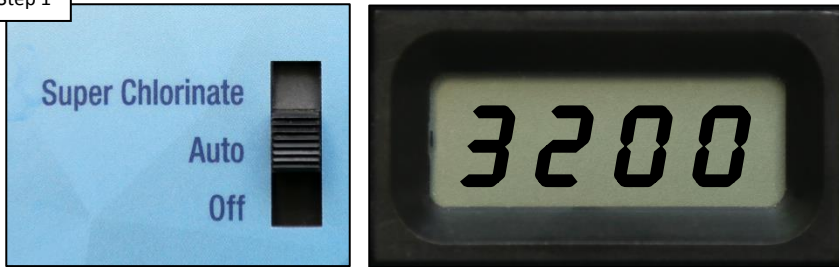

Start with the main toggle switch in the 'Auto' position.

Step 2

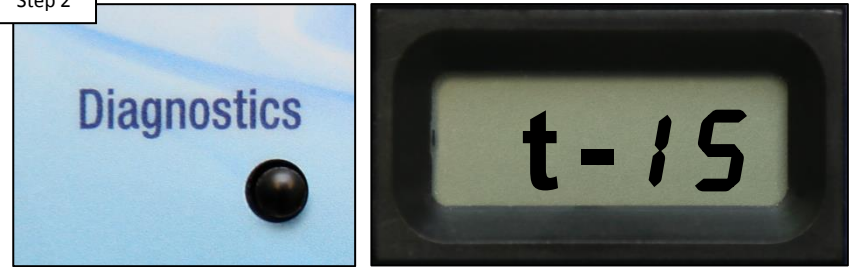

Push the diagnostics button until 't - 15, t - 9, t - 5, t - 3' appears.

Step 3

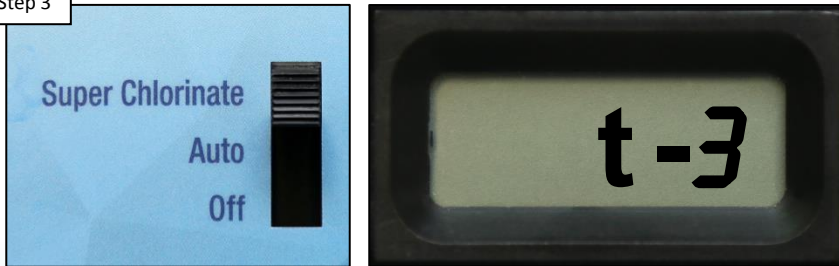

To change cell type, cycle slide switch up to 'Super Chlorinate'.

Step 4

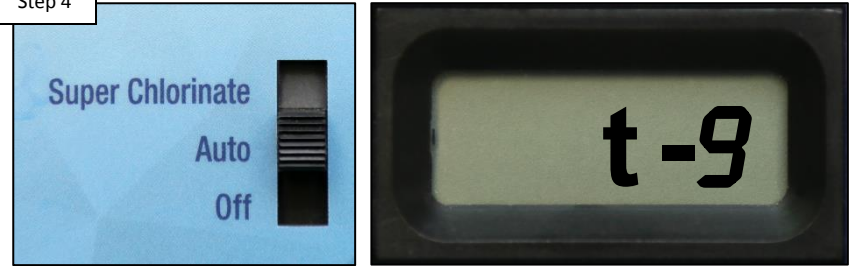

Return switch to 'AUTO'. Repeat until display shows correct cell.

# How to: Reset Average Salt Level

*The Average Salt level needs to be reset after initial start up, after a board replacement, following major pool chemistry adjustments, and when a cell is replaced.*

Step 1

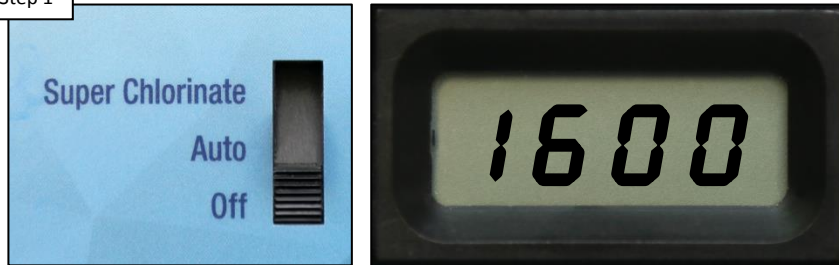

To reset, move the switch to 'Off' and then back to 'Auto'. Wait for the relay to click (5 to 10 seconds).

Step 2

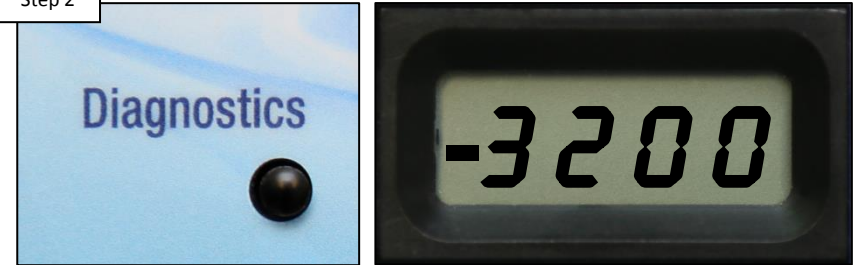

Press Diagnostics button 5 times to display the Instant Salt level. Wait for the number to stabilize.

Step 3

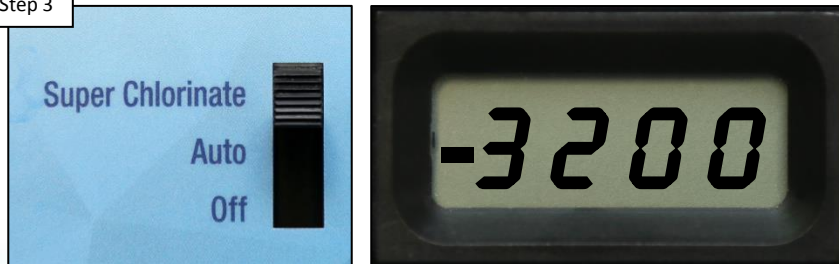

When the instant salt level is stable (and the negative sign still present), slide switch to 'Super Chlorinate' and back to 'Auto'.

Step 4

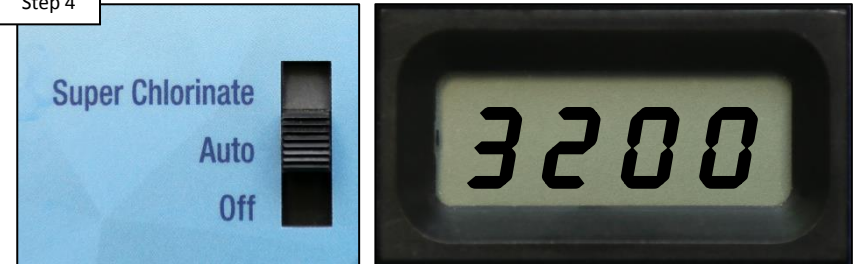

It takes about 30 seconds for the unit to settle back on the default reading. It should now reflect the new average salt level.

***NOTE: Repeat this process once more to ensure both polarities are reading within 500ppm of each other.***

# How To: Adjust Chlorine Output

The 'Desired Output %' dial, sets the level of cell operation in % of operating time, in 3 hour increments. Example: 50% (factory default) implies the cell is producing chlorine half the total pump/filter operating time; so the cell should produce chlorine for the first 90 minutes of 3 hours before repeating.

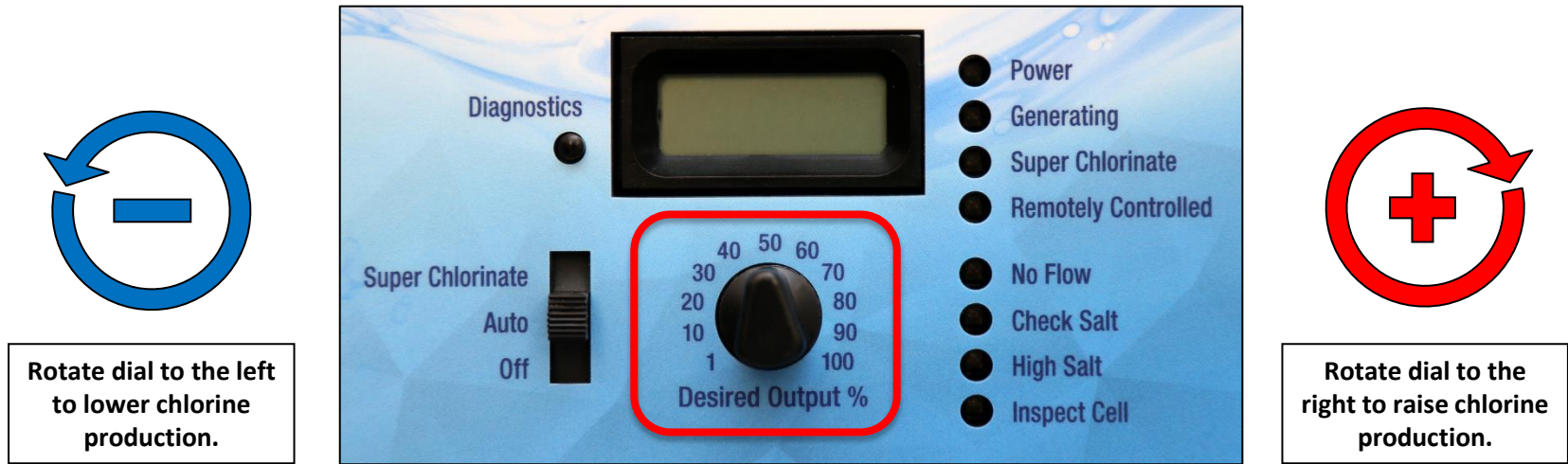

**NOTE: If the chlorine level does not increase within 24 hours after increasing output, test water using an independent test kit to determine the current salt, stabilizer, phosphate, and nitrate levels. More information related to chlorine production on Pages 41-42).**

**NOTE: Output is scaled back to 20% or lower (depending on where the dial is set) at 60 °F and chlorine production stops altogether at 50 °F.**



# How To: Clean the TurboCell

*Cell cleaning frequency is dependent on several factors; pH & calcium levels have the greatest effect on how often cells requires cleaning. In pH environments between (7.2 - 7.8) cells typically require cleaning 3-4 times a year (with moderate calcium levels).*

## Turn Pump Off & Remove Cell

Step 1

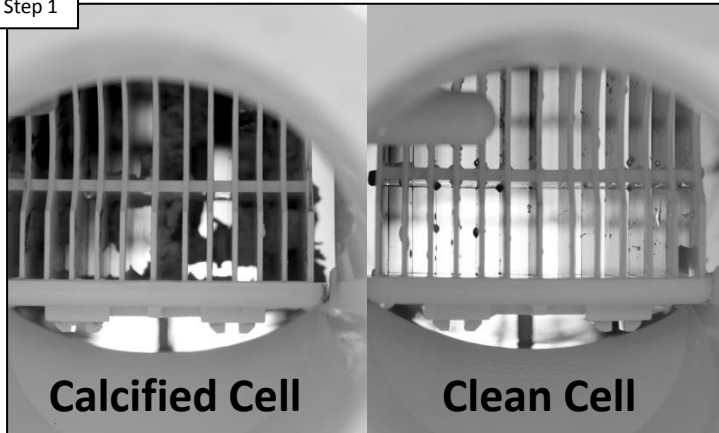

Holding the cell up to a light source, inspect for calcium deposits. Even if a TurboCell appears clean, it may still require cleaning if salt accuracy is off AND/OR chlorine production has diminished.

## Wear Protective Equipment

Step 2



If the cell requires cleaning, please wear protective equipment. It is highly recommended to use a Hayward Cell Cleaning Stand as shown on the right (GLX-CELLSTAND)

**NOTE: ALWAYS WEAR PROPER EYE PROTECTION AND PROTECTIVE GLOVES.**

**MIX SOLUTION AND CLEAN CELL ONLY IN A WELL VENTILATED AREA.**

**MURIATIC AND OTHER ACIDS CAN CAUSE SEVERE INJURY, BURNS AND RESPIRATORY PROBLEMS IF NOT HANDLED PROPERLY. REFER TO THE MANUFACTURER'S DIRECTIONS FOR SAFE HANDLING.**

# How To: Clean the TurboCell (Cont.)

*The TurboCell draws amperage when power is applied, during chlorination. The amperage draw will be impaired when calcium and other debris exist within the cell's electrolytic grid; this in turn effects the salt reading and chlorination efficiency.*

Mix: 4 Parts H<sub>2</sub>O / 1 Part Muriatic Acid

Step 3

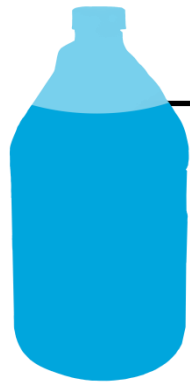

**1 Part:**  
**Muriatic Acid**

---

**4 Parts:**  
**Water**



Mix a solution comprised of 4 parts water to 1 part Muriatic Acid. **Always Add Acid to Water.** Once mixed turn the turbo up vertically either in a bucket or using the recommended cell cleaning stand.

Carefully Pour Solution into Cell

Step 4

**Cleaning Tip:**  
For best results,  
stand the cell  
vertically with  
cord-side down



Carefully pour the solution into the cell until it reaches the top. The solution should remain in the cell for 15 minute intervals until the reaction is complete. Carefully, pour solution back into approved container.

***NOTE: ALWAYS ADD ACID TO WATER! NEVER ADD WATER TO ACID.***

***The cell cleaning solution may be reused a few times.***

***ALWAYS: STORE MIXED SOLUTIONS IN A SAFE AREA, OUT OF HARMS WAY.***

***When the solution is depleted, follow the manufacturer's instructions for proper disposal.***

# How To: Clean the TurboCell (Cont.)

*The Inspect Cell LED, when flashing alone, indicates that the system is recommending the TurboCell should be inspected and cleaned (if necessary). The LED will flash alone every 500 operational hours as a reminder to inspect and/or clean the TurboCell.*

## Thoroughly Rinse Cell & Return

Step 5



After the solution has been safely removed, thoroughly rinse the TurboCell before returning it to its place in the plumbing. Once returned turn the pump back ON and proceed to the step 6.

## Reset: Inspect Cell (if applicable)

Step 6

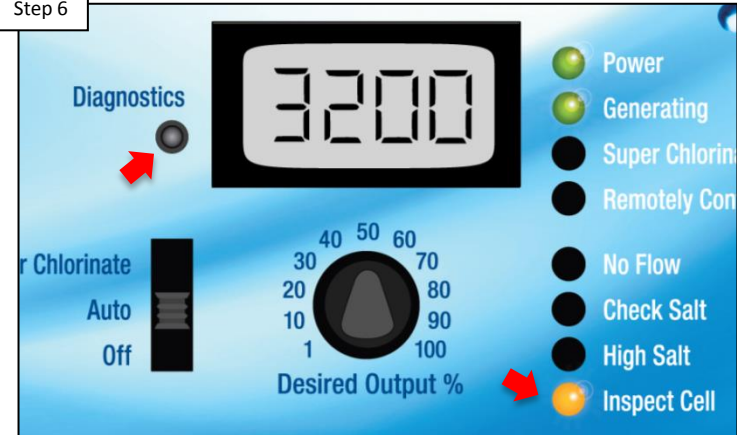

IF the "Inspect Cell" LED was flashing alone, press and hold the diagnostics button for 5 seconds OR until the Inspect Cell LED goes out. This will reset the inspect cell timer for another 500 operational hours.

***NOTE: If the cell was reading a low salt level prior to cleaning, the average salt may need to be reset. To reset the average salt level, follow the steps outlined on pg.11 or wait 24 hours for the system to acclimate to the recent changes.***





AquaRite®

# Troubleshooting





# 1. Check Salt & Inspect Cell: flashing or ON

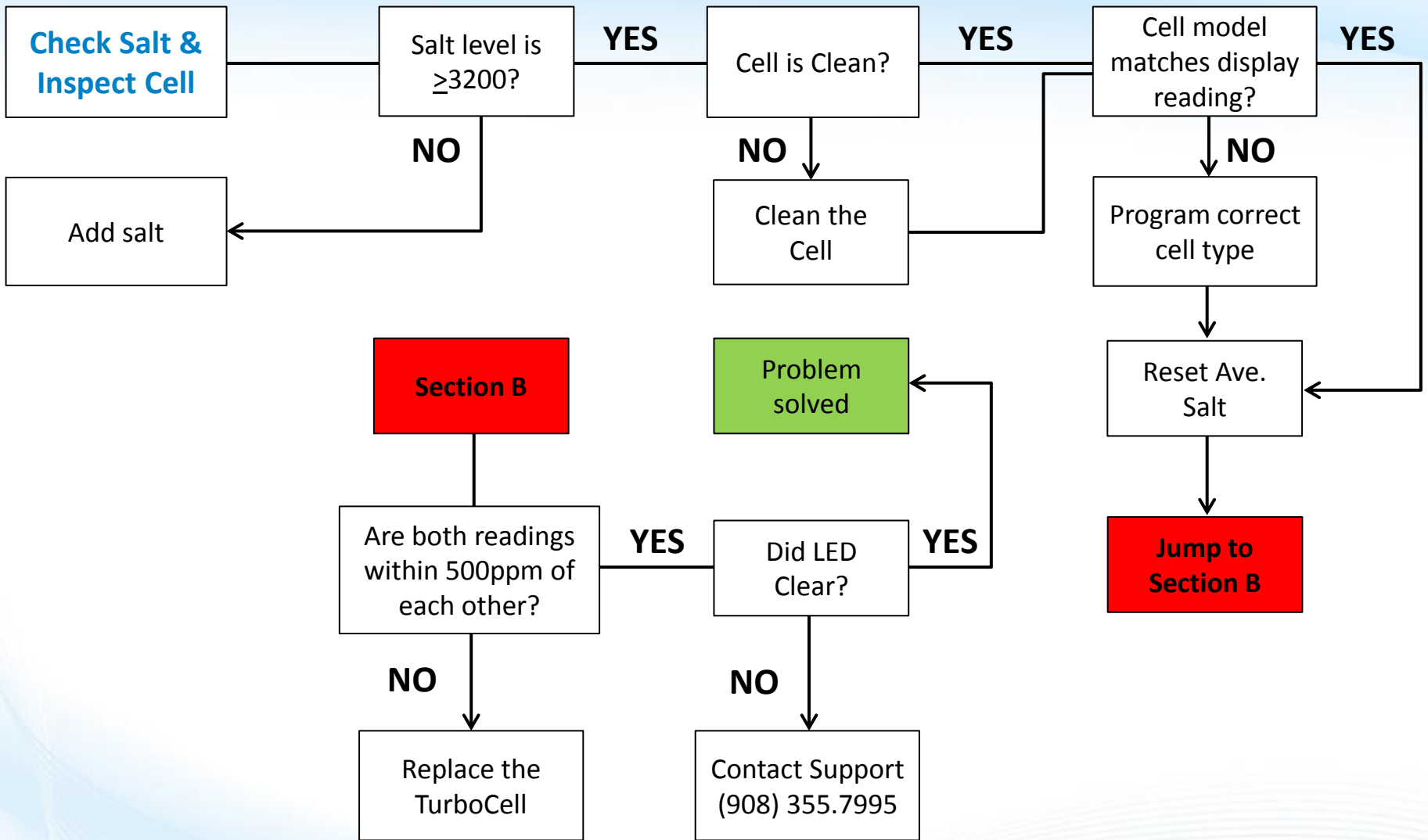

# 1. Check Salt & Inspect Cell: flashing or ON

*When these lights flash, the cell reports salt levels between 2400-2700ppm; this does not affect chlorine production. When these LEDs are ON solid, the cell reports 2300ppm or less and chlorine production is suspended.*

## Test the Salt Level

Step 1A



**Desired Salt Concentration:**  
**3200PPM**

Test the salt concentration of the water using an independent test, with a calibrated salt meter. IF the salt level is below 3200, raise the salt level ([referring to salt addition table pg. 41](#)). IF fine, go to 1B.

## Inspect the TurboCell

Step 1B

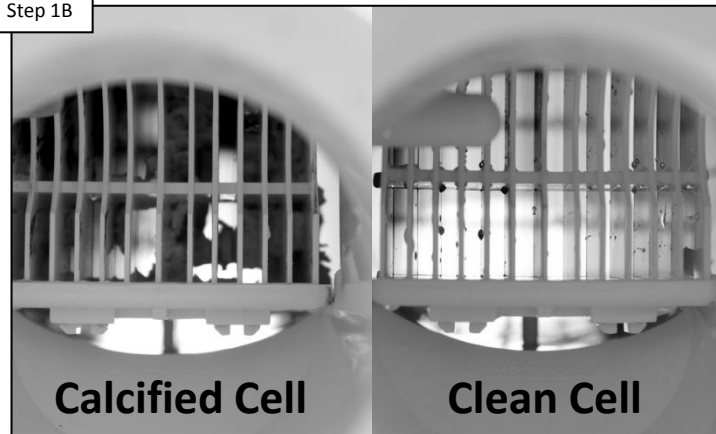

The TurboCell must be clean in order to report accurate salt readings. IF the cell looks like the image on the left, clean the cell ([pg.13-15](#)). IF cell is clean, proceed to step 1C.

*The system should be reading salt within 500ppm of an independent test. The cleanliness of the TurboCell plays a major role in the AquaRite's ability to report salt levels accurately.*

# 1. Check Salt & Inspect Cell: flashing or ON (cont.)

The AquaRite control center may be programmable to interact with different cell models ("t-15" is the factory default). Verify the TurboCell model (located on the label the wraps around the body) then compare it to what is programmed in the system.

## Correct Cell Programmed?



Verify the cell model programmed into the control center, matches the model listed on the cell. IF it does not match, change programmed cell ([refer to pg. 10](#)). IF correct, go to step 1D.

## Reset the Average Salt Level

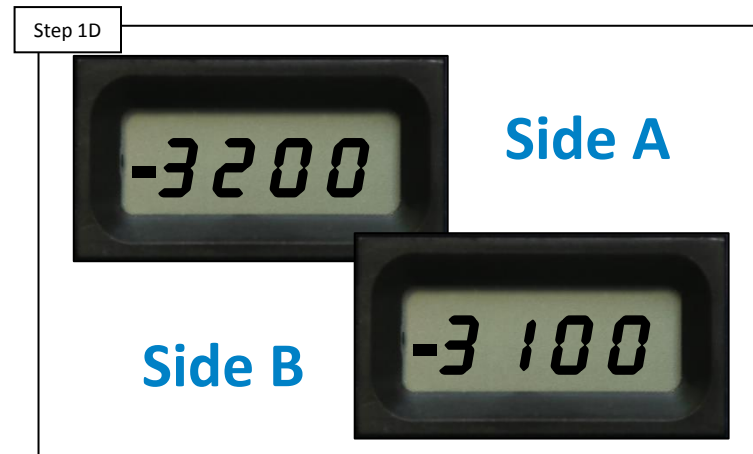

Reset the average salt level, twice, following the steps on pg. 10. Are the two instant salt level readings within 500ppm of each other? IF not go to step 1E. IF they are go to step 1F.

***There are two polarities within a TurboCell which is why it is recommended to reset twice. Although there may be some variance between these two polarities, clean cell should NEVER show more than a 500ppm variance between polarities.***

# 1. Check Salt & Inspect Cell: flashing or ON (cont.)

If the cell requires replacement, check the model number and verify whether or not the cell is under warranty. To verify warranty, please refer to pg. 44.

## Replace the TurboCell

Step 1E



### Part Numbers:

- \*T-Cell-15 OR GLX-CELL-15-W
- \*T-CELL-9 OR GLX-CELL-9-W
- \*T-CELL-3 OR GLX-CELL-3-W

The cell needs to be replaced in order for the AquaRite control center to read the salt level accurately. Replace the cell with the same model as it had prior and then reset the average salt level ([instructions on pg. 11](#)).

## Did the LEDs clear?

Step 1F

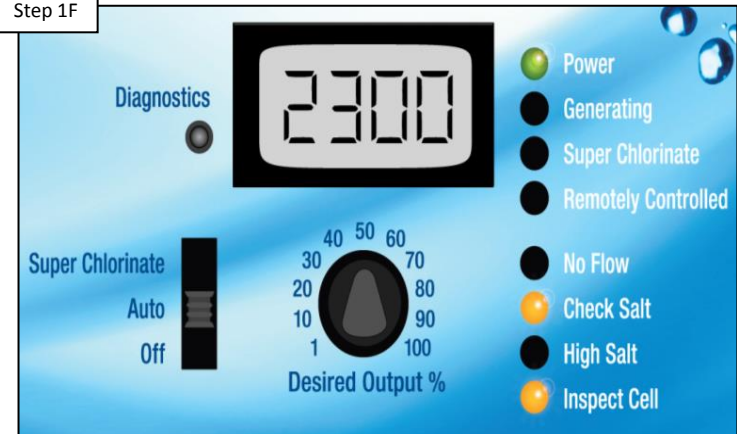

IF the "Check Salt" & "Inspect Cell" LEDs cleared, then the problem is solved. IF not please contact technical support directly by dialing: 908.355.7995 or email support via [Hayward.com](http://Hayward.com)'s support page.

**\*NOTE: When replacing the TurboCell, use the GLX-CELL-xx-W when the cell is under warranty, otherwise use the T-CELL-xx part number.**



# 2. High Salt: LED ON

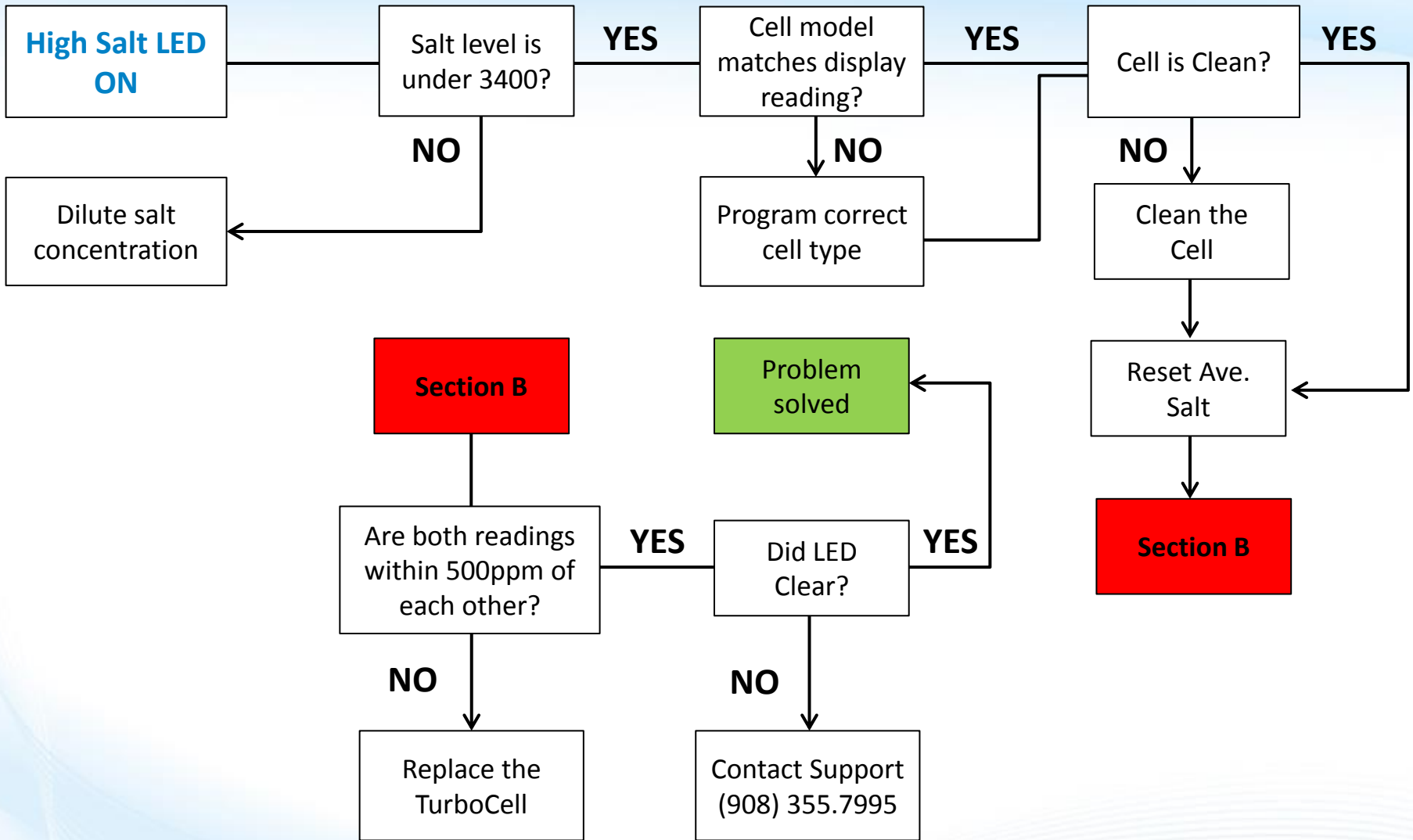

## 2. High Salt: LED ON

*The High Salt LED will appear ON solid when the maximum allowable cell amperage has been reached. The AquaRite control center will shutdown all chlorine production until the problem is solved and the LED light clears.*

### Test the Salt Level

Step 2A



**Desired Salt  
Concentration:  
3200PPM**

Test salt concentration of the water using an independent test, with a calibrated salt meter. IF salt is above 3400, go directly to 2G. IF the salt level is correct, proceed to step 2B.

### Correct Cell Programmed?

Step 2B



Verify the cell model programmed into the control center, matches the model listed on the cell. IF it does not match, change programmed cell ([refer to pg. 10](#)). IF correct, go to step 2C.

**NOTE: High water temperatures (typically found in smaller bodies of water, such as spas) can cause the High Salt LED to trigger when the salt concentration favors the high end of the range. If the water temperature is high, then consider diluting the salt level down between 2700-3200ppm.**

## 2. High Salt: LED ON (cont.)

*Although debris such as calcium typically cause low salt reading and not high ones, it is still recommended to clean out the cell. Conductive debris may cause an unwanted variance.*

### Inspect TurboCell

Step 2C



The TurboCell must be clean to report accurate salt readings. IF the cell looks like the image on the left, then clean the cell ([pg.13-15](#)). IF cell is clean, proceed to step 2D.

### Reset the Average Salt Level

Step 2D

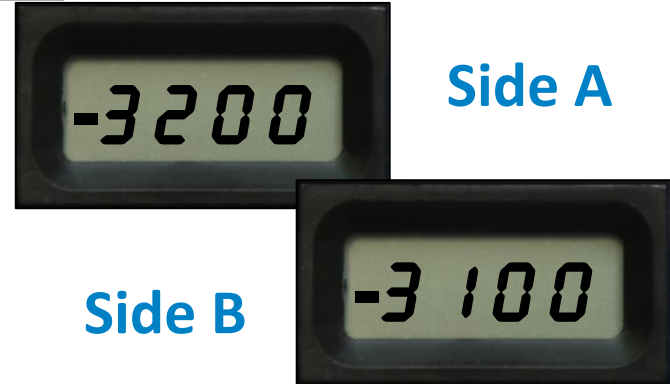

Reset the average salt level, twice, following the steps on [pg. 11](#). Are the two instant salt level readings within 500ppm of each other? IF not go to step 2E. IF they are go to step 2F.

## 2. High Salt: LED ON (cont.)

If the cell requires replacement, check the model number and verify whether or not the cell is under warranty. To verify warranty, please refer to pg. 44.

### Replace the TurboCell

Step 2E



#### Part Numbers:

- \*T-Cell-15 OR GLX-CELL-15-W
- \*T-CELL-9 OR GLX-CELL-9-W
- \*T-CELL-3 OR GLX-CELL-3-W

The cell needs to be replaced in order for the AquaRite control center to read the salt level accurately. Replace the cell with the same model as it had prior and then reset the average salt level ([instructions on pg. 11](#)).

### Did the High Salt LED clear?

Step 2F



IF the "High Salt" LED cleared, then the problem is solved. IF not please contact technical support directly by dialing: 908.355.7995 or email via [Hayward.com](http://Hayward.com)'s support page.

**\*NOTE: When replacing the TurboCell, use the GLX-CELL-xx-W when the cell is under warranty, otherwise use the T-CELL-xx part number.**



## 2. High Salt: LED ON (cont.)

To calculate how much water will need to be removed from a pool, with too much salt, follow the formula provided below (Proportional Method):

Step 2G

Part I

$$\frac{(\text{Ave. Pool Depth}'' \times 3200)}{\text{Actual Salt level in Pool}}$$

**Part 1:** Take the average depth of the pool in inches and multiply that by 3200. Then divide that number by the actual salt level in the pool (based on the independent test).

**Part 2:** Subtract the Ave. Pool Depth by the answer from part 1. This will give you the total number of inches to drain and replenish with fresh water to achieve a salt level of 3200.

Part II

$$\text{Ave. Pool Depth} - \text{Answer from Part 1} = \text{Amount of Water to Drain}$$

*Example: a pool has an ave. depth of 54'' and the salt level is 4500ppm*

Example: Part I

$$54 \times 3200 = \frac{172800}{4500} = 38.4$$

Example: Part II

$$54 - 38.4 = 15.6''$$

**Note: It is recommended to reduce the water level no more than six inches at a time before replenishing with fresh water. Failure to do so may result in damage to the pool structure or surface.**

# 3. No Flow: LED flashing or ON

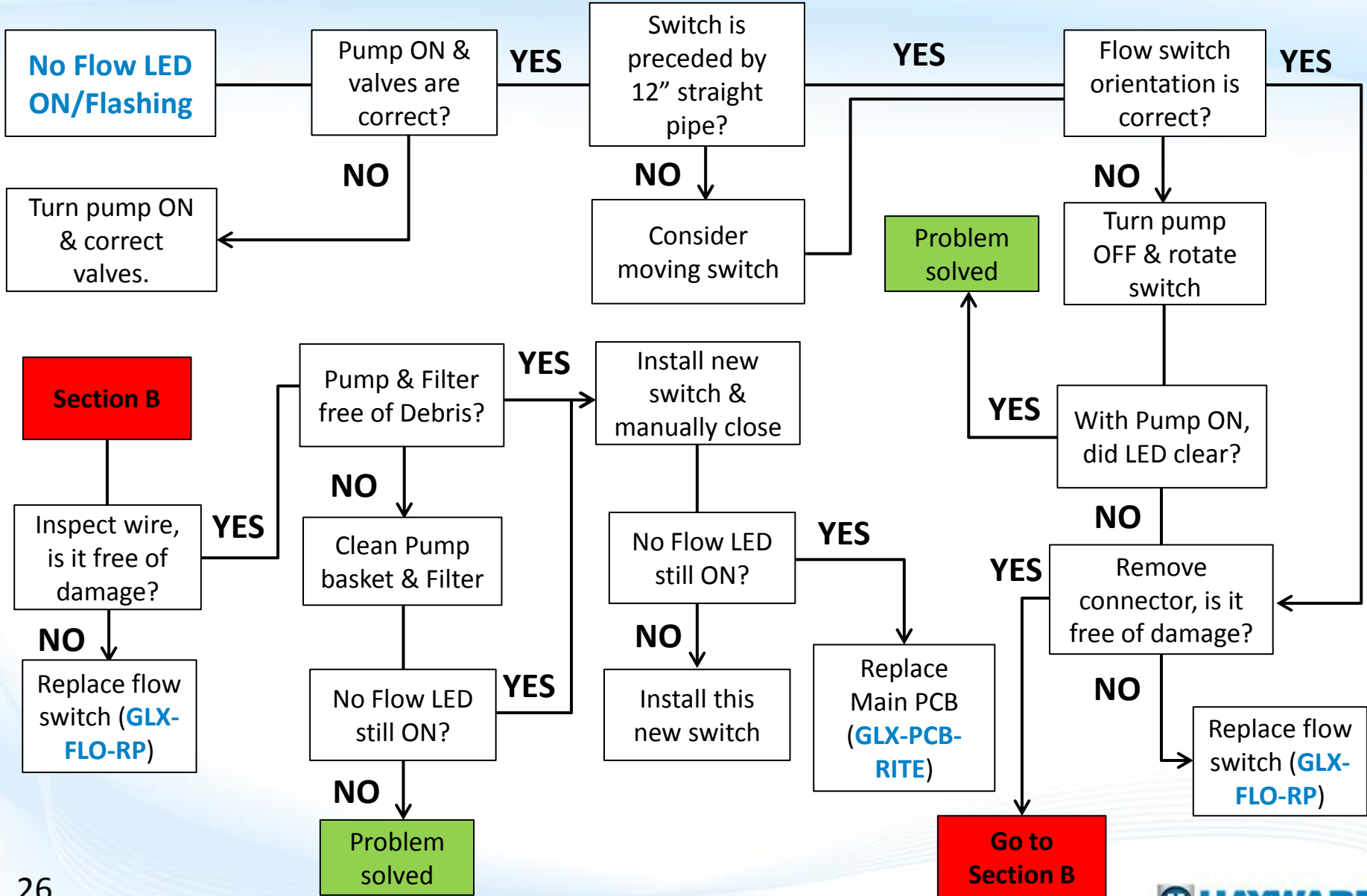

# 3. No Flow: LED flashing or ON

The “No Flow” LED indicates that the flow switch is not reporting consistent flow. When the pump initially turns on, this LED should flash for 10-60 seconds while the system verifies consistent flow.

## Pump Running & Valves are Set?

Step 3A



Verify the pump is running & valves are positioned so the flow switch is receiving water. IF the pump is not ON or the valve are not correctly set, resolve that first, then recheck. IF correct go to step 3B.

## Verify 12” of Straight Pipe

Step 3B

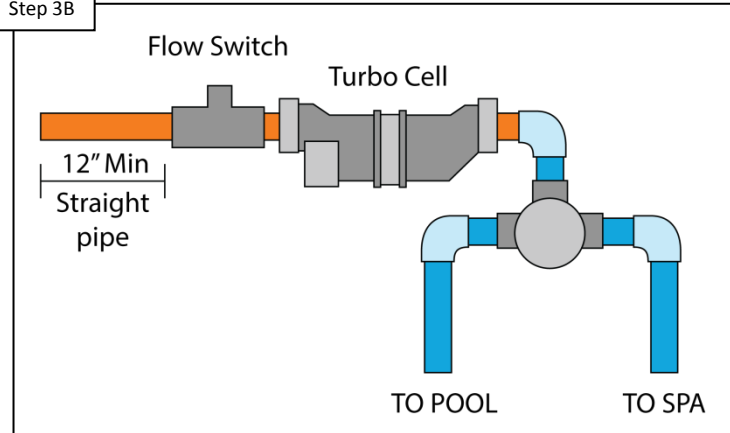

It is recommended for the flow switch to have 12” of straight pipe preceding it (the TurboCell counts as straight pipe). IF not, consider moving the flow switch. IF correct go to step 3C.

**NOTE: The flow switch requires a minimum flow rate of 11GPM in order to properly engage. If using a variable speed pump and the No Flow LED appears, try increasing the pump run speed to ensure the flow rate is not causing the problem.**

### 3. No Flow: LED flashing or ON (cont.)

*The flow switch only works in one orientation. An arrow (molded into the top of the flow switch) indicates the direction water should be flowing through the switch.*

#### Verify Flow Switch Orientation

Step 3C

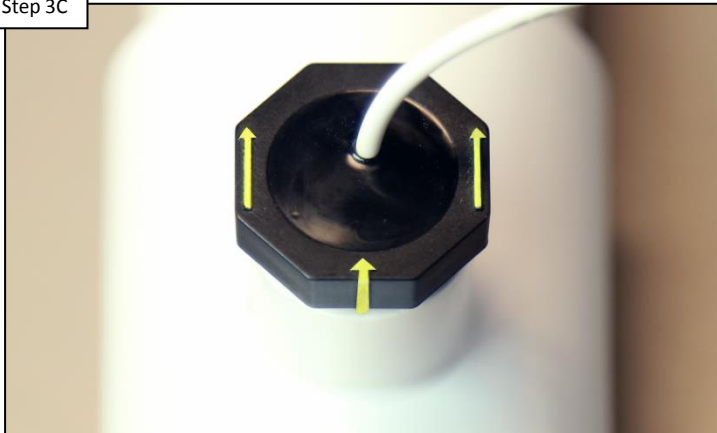

Verify the arrows (located on switch top) are pointing in the same direction water is flowing. IF incorrect, rotate the switch until it matches the direction of water flow (DO NOT OVERTIGHTEN). IF correct go to 3D.

#### Unplug Connector & Inspect

Step 3D

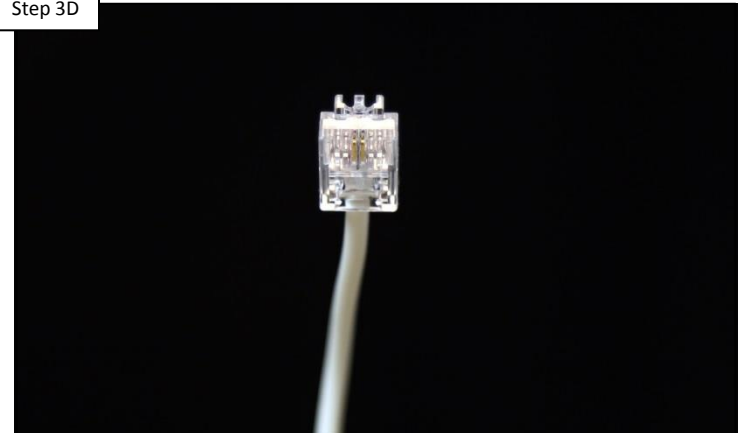

Unplug the flow switch connector & inspect. Plug the connector back in, waiting 60 seconds. IF connector is damaged, replace flow switch (GLX-FLO-RP). IF connector is not damaged, proceed to step 3E.

***The flow switch communicates through a connection similar to an RJ-11. Inspect the pins for damage or corrosion. If damaged replace the flow switch (GLX-FLO-RP) DO NOT attempt to repair.***



# 3. No Flow: LED flashing or ON (cont.)

*The flow switch wire carries the signal between the AquaRite and the flow switch. If damaged, the switch reports as an open circuit, which will suspend chlorination.*

## Inspect Flow Switch Wire

Step 3E

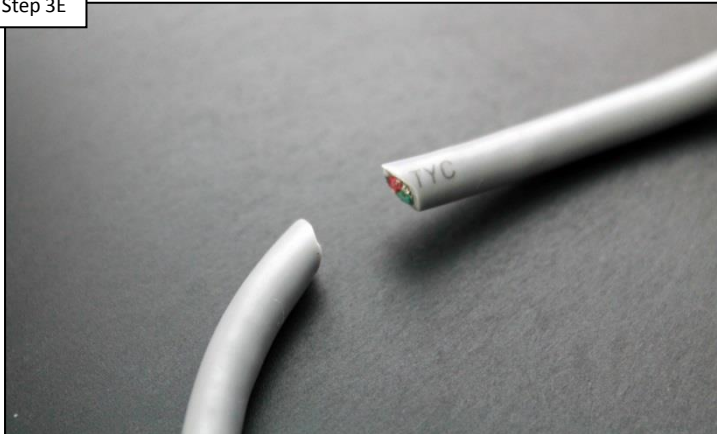

**IF the flow switch wire is damaged, the signal will be interrupted so replace the flow switch (GLX-FLO-RP). IF the wire is not damaged, proceed to step 3F.**

## Inspect Filter & all Baskets

Step 3F



**Check Filter pressure & pump basket for debris. Remove debris, backwash / clean filter. Turn pump ON & wait 60 seconds. IF LED is still ON go to 3G.**

***The Flow Switch is a safety switch. DO NOT attempt to repair the wire or the switch in any way. If compromised replace the switch (GLX-FLO-RP).***

# 3. No Flow: LED flashing or ON (cont.)

*TIP: Carry a working flow switch, because it is a great tool to have available. It will help when trying to determine whether an existing switch is failing or the main board is not sending or receiving the signal.*

## Test with New Switch

Step 3G



**Plug a confirmed (working) Flow Switch into the control center and hold it closed, manually, for 60 seconds. Monitor the “No Flow” LED. IF LED goes out, install this new switch. IF LED remains on go to step 3G.**

## Replace Main PCB

Step 3H

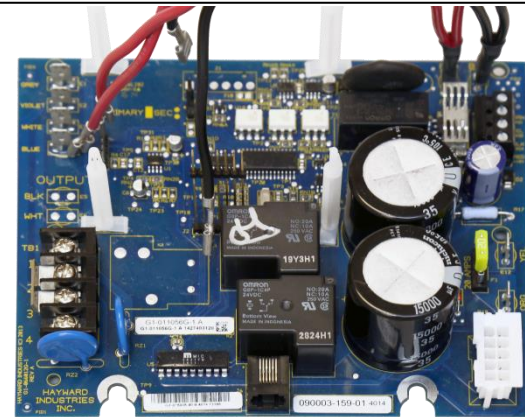

**Replace the main circuit board (**GLX-PCB-RITE**). Then, turn pump ON & monitor the “No Flow” LED. IF the LED goes out, the problem is solved. IF the LED remains on contact technical support (908.355.7995).**

# 4. Display ONLY, Lights ONLY, or Neither

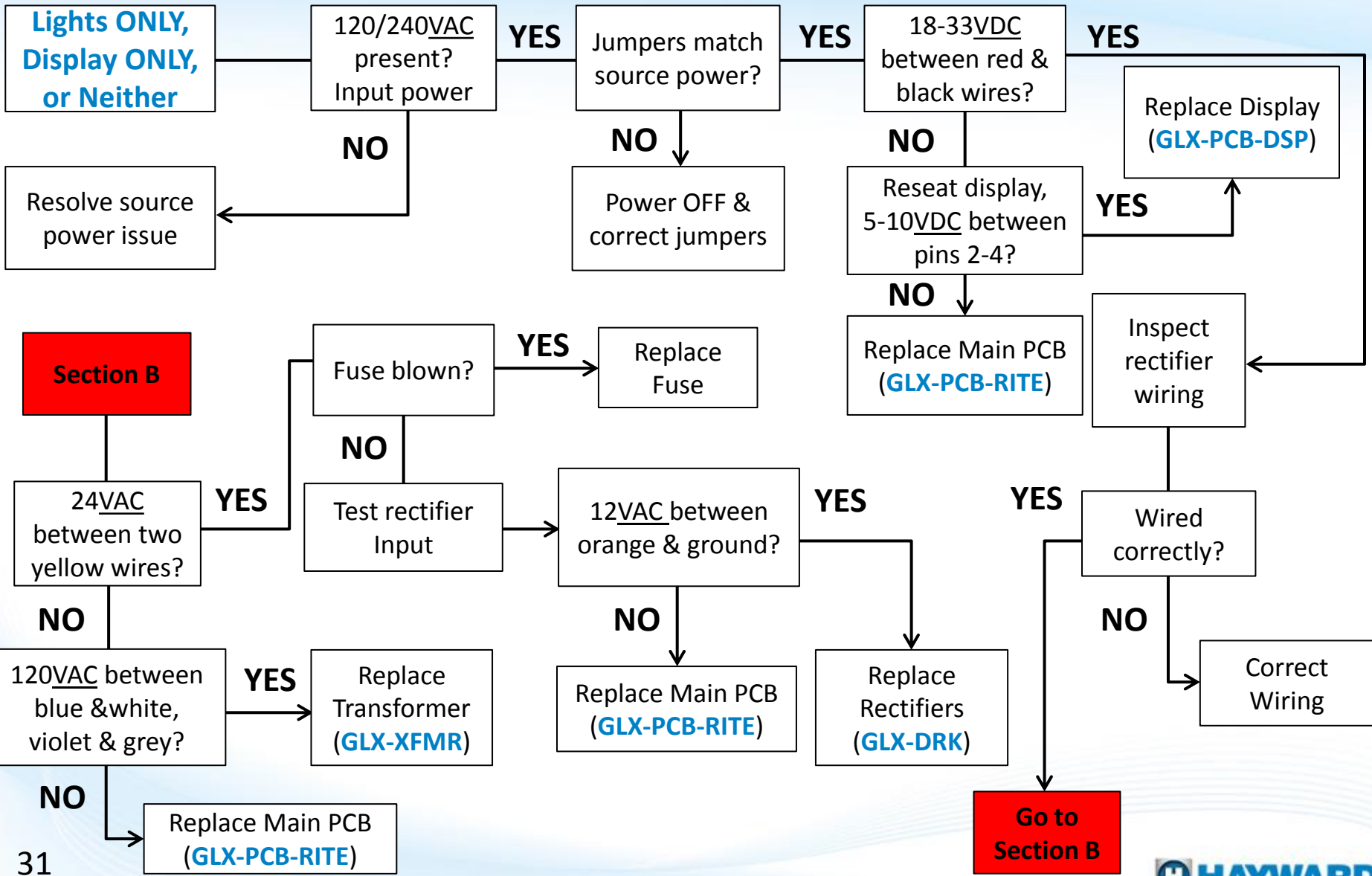

# 4. Display ONLY, Lights ONLY, or Neither

If the power center, displays LEDs ONLY, a Display reading ONLY, or Neither, then the system is exhibiting a power related symptom. First verify the incoming power. It should be either 120 or 240VAC +/- 15%. Then match the jumper configuration.

## Test Incoming Power

Step 4A

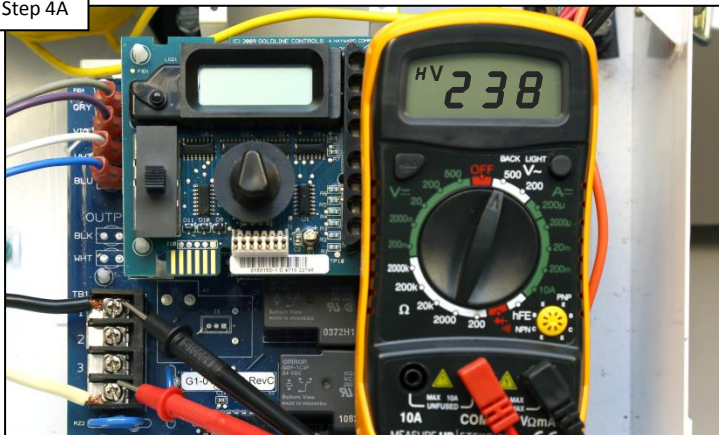

Test incoming power for 120/240VAC (+/- 15%). IF no/low voltage, then the problem resides in the power source and NOT the AquaRite control center. IF power is correct, go to step 4B.

## Match Jumpers & Incoming Power

Step 4B

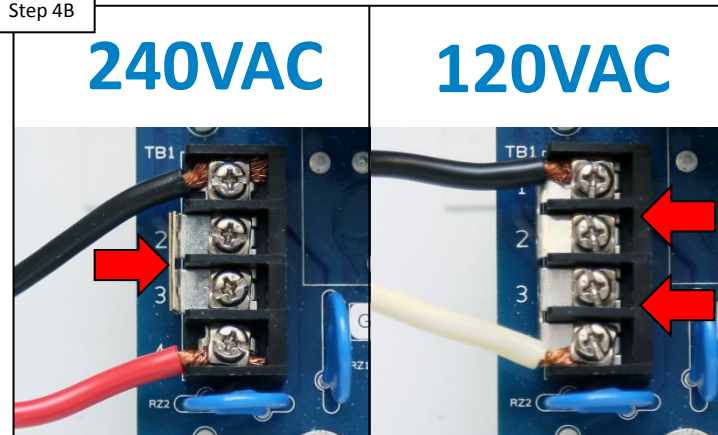

Verify jumper configuration matches incoming power. FOR 240, jumpers should be stacked between terminals 2&3 (shown on left). FOR 120VAC, jumpers span 1&2. IF incorrect, power off and change. IF correct go to 4C.

***New boards come factory preset with jumpers in the 240VAC position. ALWAYS double check power before changing jumpers. The board may be damaged if the supplied power and jumper configuration do not match.***



## 4. Display ONLY, Lights ONLY, or Neither (cont.)

*The display requires a minimum of 5VDC to function correctly. The rectifier output should provide 18-33VDC.*

### Test Rectifier Output

Step 4C

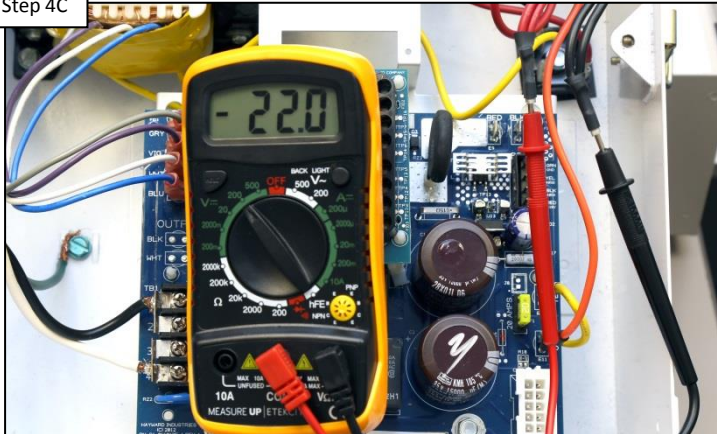

Test for 18-33VDC between the red and black wires (located in the top right hand corner of the main PCB board). IF power is correct go to step 4D. IF no/low voltage, proceed to step 4E.

### Reseat & Test Display Power

Step 4D

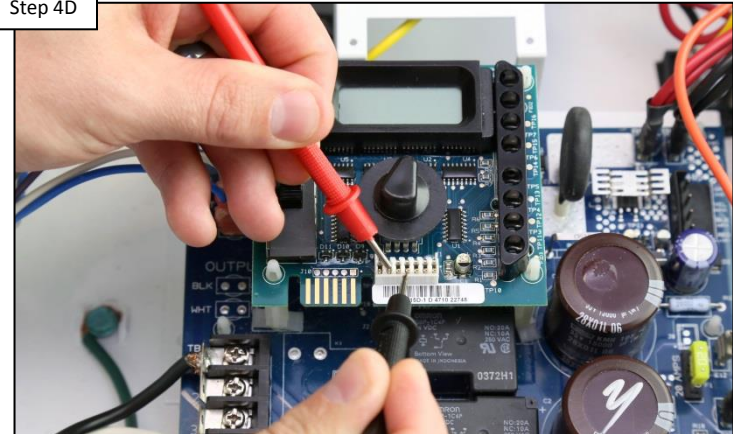

Carefully remove display from main PCB board & reseat. Test power between pins 2 & 4 (left to right), for 5-10VDC. IF no/low voltage, replace main PCB ([GLX-PCB-RITE](#)). IF correct, replace display ([GLX-PCB-DSP](#)).

*The power off the rectifiers not only provides the cell power during chlorination cycles, it also serves to power other board related functions (such as the display function).*

# 4. Display ONLY, Lights ONLY, or Neither (cont.)

The rectifiers take AC voltage from the transformer and convert it to DC voltage for both main board and chlorination functions.

## Inspect Rectifier Wiring

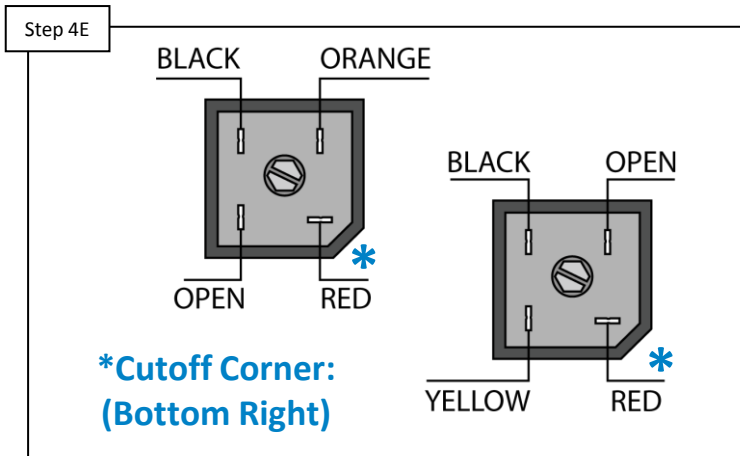

Make sure the rectifiers are wired as shown above. IF the rectifiers are incorrectly wired, correct the wiring and retest. IF the rectifiers are wired, as shown above, proceed to step 4F.

## Test Transformer Output

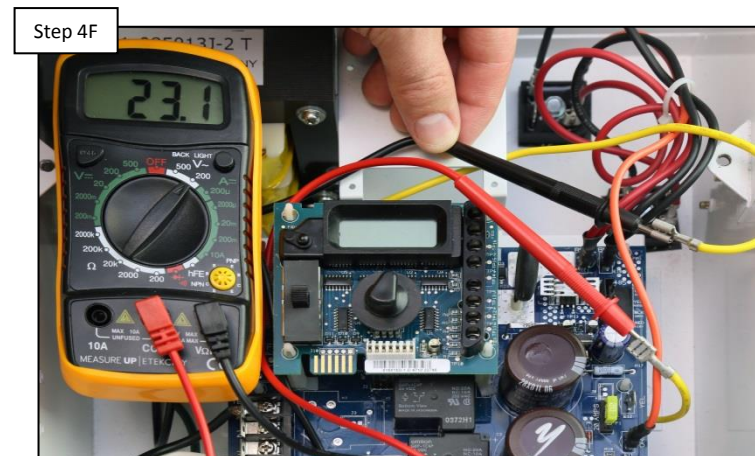

Verify 24VAC between the two yellow wires (this represents the secondary side of the transformer). IF no/low voltage go to step 4G. IF voltage is correct, jump to step 4H.

## 4. Display ONLY, Lights ONLY, or Neither (cont.)

The transformer input is split into four wires. The blue and the white carry 120VAC from the main PCB to the transformer, as do the grey and violet.

### Test Transformer Input

Step 4G

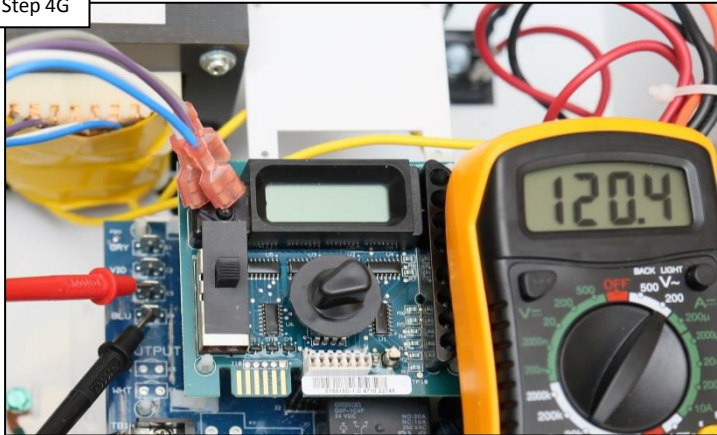

Disconnect the transformer input wires (blue, white, violet & grey). Test the board, first between the blue & white posts for 120VAC, then violet & grey for 120VAC.

IF low/no, replace main board (GLX-PCB-RITE). IF voltage is correct, replace the transformer (GLX-XFMR).

### Test the 20A Fuse

Step 4H

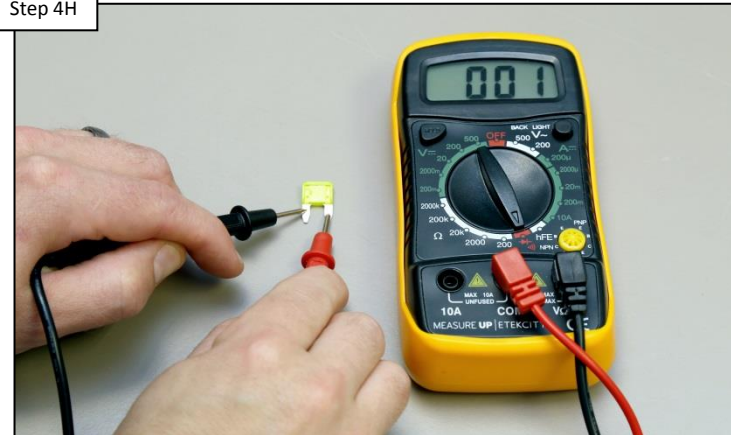

When voltage shows up on the transformer output, the transformer, and everything before it, is in good health.

Test the 20A fuse (located on the right side of the board) for continuity. IF the fuse is bad, replace it (GLX-F20A-10PK). IF okay, go to step 4I.

**NOTE: It is also important to visually inspect the fuse for damage. In rare cases, continuity may be measured in spite of a compromised fuse.**



## 4. Display ONLY, Lights ONLY, or Neither (cont.)

*The orange wire carries 12VAC of the rectifier voltage, from the main PCB to the top rectifier. Verify all connections before proceeding.*

### Test Rectifier Input

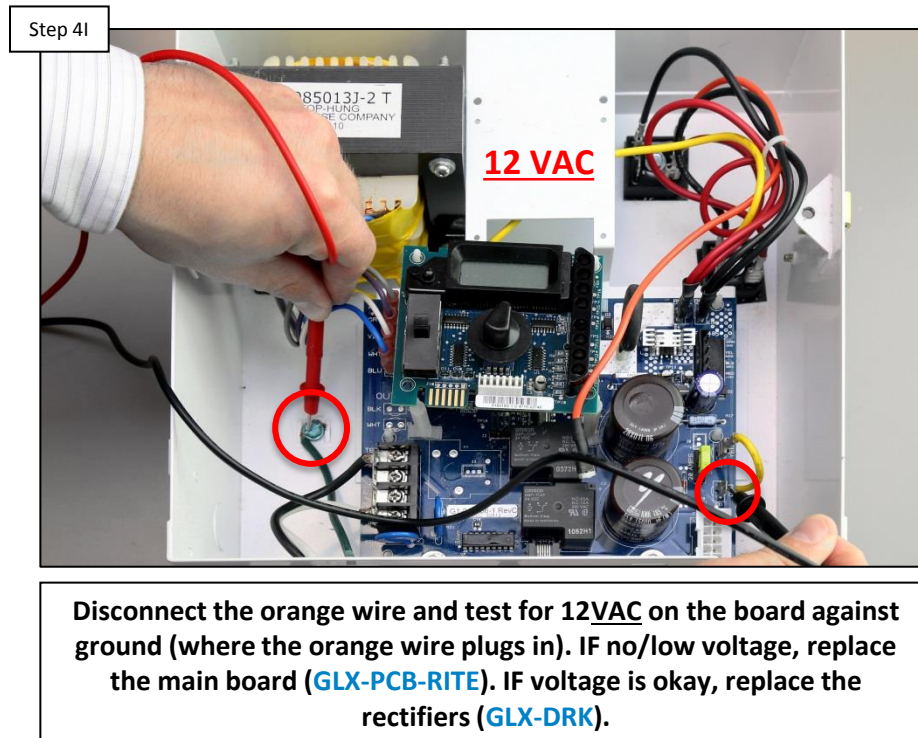



# 5. LCD: Displaying “HOT” or “COLD”

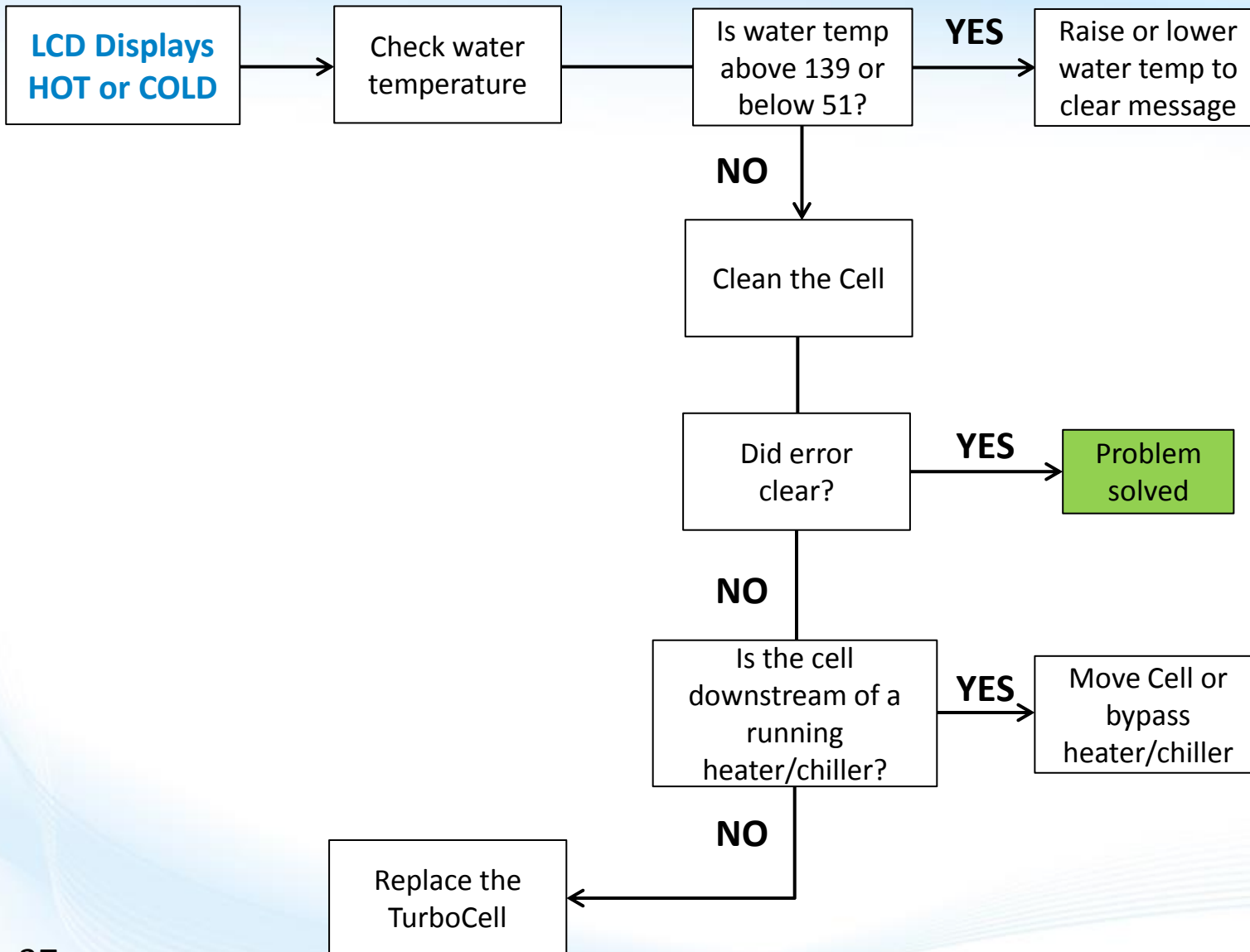

# 5. LCD: Displaying “HOT” or “COLD”

The LCD display will read “COLD” when the cell is reading water temps below 50° F.  
The LCD display will read “HOT” when the cell is reading water temps above 140° F.

## Inspect Cell

Step 5A

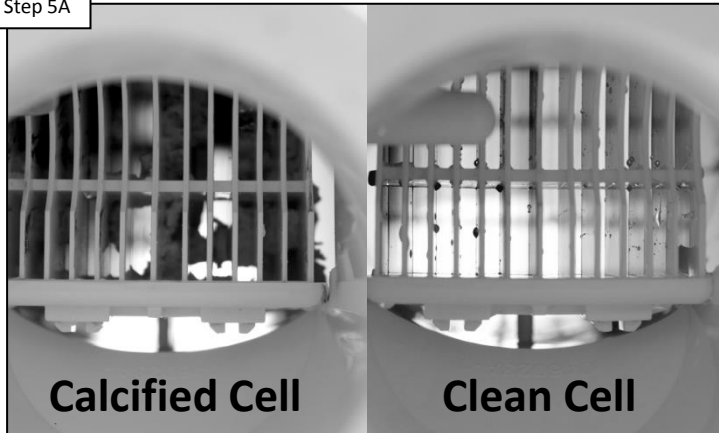

Inspect the cell for calcification. Clean the cell & reset the average salt reading (pg. 11). IF the message still appears AND the water temperature is not greater than 139F or lower than 51F, then go to 5B.

## Upstream Equipment

Step 5B

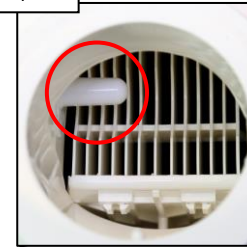

“HOT” =  $\geq 140^{\circ}\text{F}$   
“COLD” =  $\leq 50^{\circ}\text{F}$



Verify the cell is not directly downstream of a running chiller or heater. If directly downstream, this could cause false temperature readings, otherwise replace the TurboCell.

**To override a “COLD” message for 24 hrs., move the toggle switch from OFF, up to Super Chlorinate (without stopping on Auto). This will override the message for 24hours. If the system reads “HOT” it is possible the temperature sensor (within the cell) has failed and the cell will require replacement.**



AquaRite®

## Additional Information



# Software Revision: Cell Compatibility Chart

Cell Compatibility Chart										
Cell Type	Control Center Model									
	AquaRite	AquaRite XL	AquaTrol	Swimpure Plus	H40	SmartPure Sanitizer	SmartPure Sanitizer II	SP40	Guardian	Nature Soft
T-CELL-3 & GLX-CELL-3-W For residential pools up to 15,000 gallons	1.50 or later	X	X	1.50 or later	X	X	X	X	X	X
T-CELL-5 & GLX-CELL-5-W For residential pools up to 18,000 gallons	1.50 or later	X	All revisions	1.50 or later	X	All revisions	X	X	X	X
T-CELL-9 & GLX-CELL-9-W For residential pools up to 25,000 gallons	1.50 or later	X	X	1.50 or later	X	X	X	X	X	X
T-CELL-15 & GLX-CELL-15-W For residential pools up to 40,000 gallons	All revisions	All revisions	X	All revisions	All revisions	X	All revisions	All revisions	All revisions	All revisions



# Salt Addition Chart: lbs. required for 3200ppm

Current Salt Level	Pool Size - Gallons																
	8,000	10,000	12,000	14,000	16,000	18,000	20,000	22,000	24,000	26,000	28,000	30,000	32,000	34,000	36,000	38,000	40,000
0	213	267	320	373	427	480	533	587	640	693	747	800	853	907	960	1013	1067
200	200	250	300	350	400	450	500	550	600	650	700	750	800	850	900	950	1000
400	187	233	280	327	373	420	467	513	560	607	653	700	747	793	840	887	933
600	173	217	260	303	347	390	433	477	520	563	607	650	693	737	780	823	867
800	160	200	240	280	320	360	400	440	480	520	560	600	640	680	720	760	800
1000	147	183	220	257	293	330	367	403	440	477	513	550	587	623	660	697	733
1200	133	167	200	233	267	300	333	367	400	433	467	500	533	567	600	633	667
1400	120	150	180	210	240	270	300	330	360	390	420	450	480	510	540	570	600
1600	107	133	160	187	213	240	267	293	320	347	373	400	427	453	480	507	533
1800	93	117	140	163	187	210	233	257	280	303	327	350	393	397	420	443	467
2000	80	100	120	140	160	180	200	220	240	260	280	300	320	340	360	380	400
2200	67	83	100	117	133	150	167	183	200	217	233	250	267	283	300	317	333
2400	53	67	80	93	107	120	133	147	160	173	187	200	213	227	240	253	267
2600	40	50	60	70	80	90	100	110	120	130	140	150	160	170	180	190	200
2800	27	33	40	47	53	60	67	73	80	87	93	100	107	113	120	127	133
3000	13	17	20	23	27	30	33	37	40	43	47	50	53	57	60	63	67
3200	Ideal	Ideal	Ideal	Ideal	Ideal	Ideal	Ideal	Ideal	Ideal	Ideal	Ideal	Ideal	Ideal	Ideal	Ideal	Ideal	Ideal
3400	OK	OK	OK	OK	OK	OK	OK	OK	OK	OK	OK	OK	OK	OK	OK	OK	OK
3600+	Dilute	Dilute	Dilute	Dilute	Dilute	Dilute	Dilute	Dilute	Dilute	Dilute	Dilute	Dilute	Dilute	Dilute	Dilute	Dilute	Dilute

*Note: Prior to adding salt, always test water with independent tests to determine current salt and stabilizer levels.*

## How to add salt

Brushing the salt around will speed up the dissolving process. DO NOT allow the salt to sit in a pile at the bottom of the pool. Salt water is heavier than fresh water, so the salt water will tend to accumulate at the deepest part of the pool. Run the filter system with the suction coming from the main drain for 24 hours to evenly distribute the salt throughout the pool

*Note: Refer to the Plasters recommendations for cure time before adding salt.*

# Chlorine Output & Salt Levels

1. With Firmware Revision 1.55 (5/8/2009) the cycle time (reversal of polarity) changed from 120 minutes (2 hrs) to 180 minutes (3 hrs). When you set the 'Desired Output %' dial on the main panel this sets the level of salt cell operation as a percent of the operating time of each cycle. 50% is the factory default. Below are simple examples for 2 and 3 hr cycle times.
  - **2 hr cycle:** If the output is set at 50% and the total time for operation is 8 hrs, the salt cell will operate (and produce chlorine) for 50% (1 hr) of each 2hr cycle for a total of 4 hrs.
  - **3 hr cycle:** If the output is set at 50% and the total time for operation is 9 hrs, the salt cell will operate (and produce chlorine) for 50% (1.5 hrs) of each 3 hrs cycle for a total of 4.5 hrs
2. Super-chlorinate is an additional option to use in order to 'catch up' in chlorine production when making adjustments to the desired output level. Move the switch to 'Super Chlorinate' to enable. This will cause the system to produce chlorine at 100% output for 24 hours assuming the pump remains on constant for 24hours. Once 24 hours expires, the chlorine output dial will once again drive the chlorine output percentage.

# Chlorine Output & Salt Levels (cont.)

3. It is possible that the displayed salt level can be significantly different from the actual salt level (when measured through an independent test). This can happen as a result of a dirty cell or from a cell that is experiencing the aging process. Low salt readings should ALWAYS be followed by a cell cleaning first and then an actual meter measurement of the salt level in the water. If the cell is clean and the level of salt measured in the water is correct, then the cell has started to age, which results in a lower calculated salt level. This is an acceptable situation, assuming the level of free chlorine in the pool is appropriate. NEVER add additional salt in this circumstance.
4. If the free chlorine is not appropriate and the steps in item 2 have been followed and addressed as needed, then the 'Desired Output %' needs to be increased in a 25% increment (for example from 50% to 75%) to allow for the TurboCell to operate for a longer period (% of total operating time) in order to produce a sufficient amount of chlorine as the cell begins to age. Allow 24 hours and re-test free chlorine. Increase in increments of +10% if required. Keep in mind this is assuming the chemistry parameters are correct in the pool and there is nothing that is creating a significant chlorine demand. Also, it is common to have to increase the chlorine output % when the heat of the season, when a-typical temperatures are recorded.

# Reading Serial Numbers

*Beginning 08-05-2011*

3A11284-123456

3A11284 = Standard Warranty Term

3A11284 = Product Family

3A11284 = Year of Manufacture

3A11284 = Day of Manufacture

123456 = Manufacturing ID

*Beginning 11-01-2001*

3A0112-123456

3A0112 = Standard Warranty Term

3A0112 = Product Family

3A0112 = Year of Manufacture

3A0112 = Month of Manufacture

123456 = Manufacturing ID